

Minnesota Wetland Conservation Act Notice of Application

Local Government Unit: City of Golden Valley	County: Hennepin
Applicant Name: City of Golden Valley	Applicant Representative: Jeff Oliver
Project Name: Glenwood Ave Pond Maintenance	LGU Project No. (if any):
Date Complete Application Received by LGU: 09/30/2020	
Date this Notice was Sent by LGU: 09/30/2020	
Date that Comments on this Application Must Be Received By LGU¹: 10/21/2020	

¹ minimum 15 business day comment period for Boundary & Type, Sequencing, Replacement Plan and Bank Plan Applications

WCA Decision Type - check all that apply

<input type="checkbox"/> Wetland Boundary/Type	<input type="checkbox"/> Sequencing	<input type="checkbox"/> Replacement Plan	<input type="checkbox"/> Bank Plan (not credit purchase)
<input checked="" type="checkbox"/> No-Loss (8420.0415)	<input type="checkbox"/> Exemption (8420.0420)		
Part: <input type="checkbox"/> A <input type="checkbox"/> B <input type="checkbox"/> C <input type="checkbox"/> D <input checked="" type="checkbox"/> E <input type="checkbox"/> F <input type="checkbox"/> G <input type="checkbox"/> H		Subpart: <input type="checkbox"/> 2 <input type="checkbox"/> 3 <input type="checkbox"/> 4 <input type="checkbox"/> 5 <input type="checkbox"/> 6 <input type="checkbox"/> 7 <input type="checkbox"/> 8 <input type="checkbox"/> 9	

Replacement Plan Impacts (replacement plan decisions only)

Total WCA Impact Area Proposed: NA

Application Materials

<input checked="" type="checkbox"/> Attached <input type="checkbox"/> Other ¹ (specify):

¹ Link to ftp or other accessible file sharing sites is acceptable.

Comments on this application should be sent to:

LGU Contact Person: Roxy Robertson (WSB) and Jeff Oliver (City of Golden Valley)
E-Mail Address: rrobertson@wsbeng.com
Address and Phone Number: 763-762-2844
Decision-Maker for this Application:
<input checked="" type="checkbox"/> Staff <input type="checkbox"/> Governing Board/Council <input type="checkbox"/> Other (specify):

Notice Distribution (include name)

Required on all notices:

<input checked="" type="checkbox"/> SWCD TEP Member: Stacey Lijewski	<input checked="" type="checkbox"/> BWSR TEP Member: Ben Carlson
<input checked="" type="checkbox"/> LGU TEP Member (if different than LGU contact): Jeff Oliver	
<input type="checkbox"/> DNR Representative:	
<input checked="" type="checkbox"/> Watershed District or Watershed Mgmt. Org.: Laura Jester (BCWMC)	
<input type="checkbox"/> Applicant (notice only):	<input type="checkbox"/> Agent/Consultant (notice only):

Optional or As Applicable:

<input checked="" type="checkbox"/> Corps of Engineers:	
<input type="checkbox"/> BWSR Wetland Mitigation Coordinator (required for bank plan applications only):	
<input type="checkbox"/> Members of the Public (notice only):	<input type="checkbox"/> Other:

Signature: 	Date: 9/30/2020
--	------------------------

This notice and accompanying application materials may be sent electronically or by mail. The LGU may opt to send a summary of the application to members of the public upon request per 8420.0255, Subp. 3.

Project Name and/or Number: Golden Valley Pond Maintenance (WSB No. 015875-000)

PART ONE: Applicant Information

If applicant is an entity (company, government entity, partnership, etc.), an authorized contact person must be identified. If the applicant is using an agent (consultant, lawyer, or other third party) and has authorized them to act on their behalf, the agent's contact information must also be provided.

Applicant/Landowner Name: City of Golden Valley (Jeff Oliver)
Mailing Address: 7800 Golden Valley Road, Golden Valley, MN 55427
Phone: 763-593-8034
E-mail Address: joliver@goldenvalleymn.gov

Authorized Contact (do not complete if same as above):

Mailing Address:
Phone:
E-mail Address:

Agent Name: WSB (Roxy Robertson)
Mailing Address: 178 9th Street East #200, St. Paul, MN 55101
Phone: 763-762-2844
E-mail Address: rrobertson@wsbeng.com

PART TWO: Site Location Information

County: Hennepin **City/Township:** Golden Valley
Parcel ID and/or Address: Pond SL-13: 3211821440030, 3211821440031, 3211821440017, 3211821440018
*The city has easements over both pond areas.

Legal Description (Section, Township, Range): 32, 118, 21

Lat/Long (decimal degrees): 44.979889°, -93.362873°

Attach a map showing the location of the site in relation to local streets, roads, highways. Figure 1, Appendix A

Approximate size of site (acres) or if a linear project, length (feet): 0.70

If you know that your proposal will require an individual Permit from the U.S. Army Corps of Engineers, you must provide the names and addresses of all property owners adjacent to the project site. This information may be provided by attaching a list to your application or by using block 25 of the Application for Department of the Army permit which can be obtained at:

http://www.mvp.usace.army.mil/Portals/57/docs/regulatory/RegulatoryDocs/engform_4345_2012oct.pdf

PART THREE: General Project/Site Information

*If this application is related to a delineation approval, exemption determination, jurisdictional determination, or other correspondence submitted **prior to** this application then describe that here and provide the Corps of Engineers project number.*

No wetland delineation has been completed for this pond cleanout site because they qualify for a No Loss under MN Rules 8420, where a specific wetland boundary is not needed.

Describe the project that is being proposed, the project purpose and need, and schedule for implementation and completion. The project description must fully describe the nature and scope of the proposed activity including a description of all project elements

that effect aquatic resources (wetland, lake, tributary, etc.) and must also include plans and cross section or profile drawings showing the location, character, and dimensions of all proposed activities and aquatic resource impacts.

Project Purpose

The City of Golden Valley is proposing to remove accumulated sediment from a stormwater ponds located within the City for the purpose of pond maintenance. The pond is identified as follows:

Aquatic Resource ID	Legal Description	Lat/Long	Total Pond Size
Pond SL-13	32, 118, 21	44.979889°, -93.362873°	0.70

Project Description and Need

Pond SL-13 is located northeast of the intersection of Glenwood Avenue and Georgia Avenue N. Based on a review of available historic aerial imagery dating back to 1937, this location appears to have been a historic wetland (**Figure 2, Appendix A**). Soils at this location are mapped as Udorthents, wet substratum (U2A) and are classified as non-hydric (**Figure 3, Appendix A**). In 1937, the pond area was a farmed wetland. The existing stormwater pond was likely constructed during the construction of the surrounding housing development in the 1900s, according to county parcel records. Over time, approximately 1.5 feet of sediment has accumulated within the stormwater pond and it is due for maintenance in order for the pond to maintain its function for water treatment and storage. This project will remove accumulated sediment to return the pond to its original depth, with the proposed pond bottom at an elevation of 892 and a normal water level of 894.5. Sediment within the pond was tested for contaminants and was determined to have a Soil Reference Value of Level 2 per the Minnesota Pollution Control Agency (MPCA) guidelines. This means that the material is suitable for re-use on properties with an industrial use category. The project will also expand the pond (as shown on the plans) by excavating within the adjacent upland of the pond to create more storage.

The construction plans for the project are included in **Appendix B**.

Schedule

Construction and excavation in December 2020

Final completion by June 2021

PART FOUR: Aquatic Resource Impact¹ Summary

If your proposed project involves a direct or indirect impact to an aquatic resource (wetland, lake, tributary, etc.) identify each impact in the table below. Include all anticipated impacts, including those expected to be temporary. Attach an overhead view map, aerial photo, and/or drawing showing all of the aquatic resources in the project area and the location(s) of the proposed impacts. Label each aquatic resource on the map with a reference number or letter and identify the impacts in the following table.

Accumulated sediment will be removed across the majority of the wetland. See the project plans in **Appendix B**.

Aquatic Resource ID (as noted on overhead view)	Aquatic Resource Type (wetland, lake, tributary etc.)	Type of Impact (fill, excavate, drain, or remove vegetation)	Duration of Impact Permanent (P) or Temporary (T) ¹	Size of Impact ²	Overall Size of Aquatic Resource ³	Existing Plant Community Type(s) in Impact Area ⁴	County, Major Watershed #, and Bank Service Area # of Impact Area ⁵	WCA Regulation	COE Regulation
Pond SL-13	Pond	Excavation	P	0.70 acres	0.70 acres	Shallow Open Water	Hennepin, 20, 7	No Loss	NWP 43

¹If impacts are temporary; enter the duration of the impacts in days next to the "T". For example, a project with a temporary access fill that would be removed after 220 days would be entered "T (220)".

²Impacts less than 0.01 acre should be reported in square feet. Impacts 0.01 acre or greater should be reported as acres and rounded to the nearest 0.01 acre. Tributary impacts must be reported in linear feet of impact and an area of impact by indicating first the linear feet of impact along the flowline of the stream followed by the area impact in parentheses). For example, a project that impacts 50 feet of a stream that is 6 feet wide would be reported as 50 ft (300 square feet).

³This is generally only applicable if you are applying for a de minimis exemption under MN Rules 8420.0420 Subp. 8, otherwise enter "N/A".

⁴Use Wetland Plants and Plant Community Types of Minnesota and Wisconsin 3rd Ed. as modified in MN Rules 8420.0405 Subp. 2.

⁵Refer to Major Watershed and Bank Service Area maps in MN Rules 8420.0522 Subp. 7.

If any of the above identified impacts have already occurred, identify which impacts they are and the circumstances associated with each:

NA

PART FIVE: Applicant Signature

Check here if you are requesting a pre-application consultation with the Corps and LGU based on the information you have provided. Regulatory entities will not initiate a formal application review if this box is checked.

By signature below, I attest that the information in this application is complete and accurate. I further attest that I possess the authority to undertake the work described herein.

Signature: Jeff Oliver Date: 09/29/2020

I hereby authorize WSB to act on my behalf as my agent in the processing of this application and to furnish, upon request, supplemental information in support of this application.

¹ The term "impact" as used in this joint application form is a generic term used for disclosure purposes to identify activities that may require approval from one or more regulatory agencies. For purposes of this form it is not meant to indicate whether or not those activities may require mitigation/replacement.

Attachment A

Request for Delineation Review, Wetland Type Determination, or Jurisdictional Determination

By submission of the enclosed wetland delineation report, I am requesting that the U.S. Army Corps of Engineers, St. Paul District (Corps) and/or the Wetland Conservation Act Local Government Unit (LGU) provide me with the following (check all that apply):

Wetland Type Confirmation

Delineation Concurrence. Concurrence with a delineation is a written notification from the Corps and a decision from the LGU concurring, not concurring, or commenting on the boundaries of the aquatic resources delineated on the property. Delineation concurrences are generally valid for five years unless site conditions change. Under this request alone, the Corps will not address the jurisdictional status of the aquatic resources on the property, only the boundaries of the resources within the review area (including wetlands, tributaries, lakes, etc.).

Preliminary Jurisdictional Determination. A preliminary jurisdictional determination (PJD) is a non-binding written indication from the Corps that waters, including wetlands, identified on a parcel may be waters of the United States. For purposes of computation of impacts and compensatory mitigation requirements, a permit decision made on the basis of a PJD will treat all waters and wetlands in the review area as if they are jurisdictional waters of the U.S. PJDs are advisory in nature and may not be appealed.

Approved Jurisdictional Determination. An approved jurisdictional determination (AJD) is an official Corps determination that jurisdictional waters of the United States are either present or absent on the property. AJDs can generally be relied upon by the affected party for five years. An AJD may be appealed through the Corps administrative appeal process.

In order for the Corps and LGU to process your request, the wetland delineation must be prepared in accordance with the 1987 Corps of Engineers Wetland Delineation Manual, any approved Regional Supplements to the 1987 Manual, and the *Guidelines for Submitting Wetland Delineations in Minnesota* (2013).

<http://www.mvp.usace.army.mil/Missions/Regulatory/DelineationJDGuidance.aspx>

Attachment B

Supporting Information for Applications Involving Exemptions, No Loss Determinations, and Activities Not Requiring Mitigation

Complete this part *if* you maintain that the identified aquatic resource impacts in Part Four do not require wetland replacement/compensatory mitigation OR *if* you are seeking verification that the proposed water resource impacts are either exempt from replacement or are not under CWA/WCA jurisdiction.

Identify the specific exemption or no-loss provision for which you believe your project or site qualifies:

MN Rules 8420.0415.E.

MN Rules 8420.0105 Subpart 1

NWP 43 – Stormwater Management Facilities

Provide a detailed explanation of how your project or site qualifies for the above. Be specific and provide and refer to attachments and exhibits that support your contention. Applicants should refer to rules (e.g. WCA rules), guidance documents (e.g. BWSR guidance, Corps guidance letters/public notices), and permit conditions (e.g. Corps General Permit conditions) to determine the necessary information to support the application. Applicants are strongly encouraged to contact the WCA LGU and Corps Project Manager prior to submitting an application if they are unsure of what type of information to provide:

Minnesota Rules 8420.0415.E No Loss criteria allows for the excavation within a wetland limited to the removal of deposited sediment in the wetland that are presently utilized as storm water management basins, or excavation and removal of contaminated substrate, when the excavated area is limited to the minimum dimensions necessary for achieving the desired purpose and stabilized to prevent water quality degradation. The removal of material from the pond will be limited to only accumulated sediment and all disturbed areas adjacent to the pond will be stabilized with State Seed Mix 34-261/21-111 or 25-151/21-111, and Cat. 3N/2S erosion control blanket within 7 days of ceasing active work.

Minnesota Rules 8420.0105 Subpart 1 regulates the draining or filling of wetlands, not uplands. The proposed excavation beyond the pond boundary will occur in upland and will expand the pond to provide more storage.

The project qualifies for maintenance under Nationwide Permit (NWP) 43 (**Appendix C**), where the permit authorizes discharges for the maintenance of stormwater management facilities so long as the discharge does not cause a loss of greater than ½-acre of WOUS. This project will have no permanent impacts and will only return the pond to past constructed conditions. Under this NWP notification requirements, maintenance activities do not require a pre-construction notification if they are limited to restoring the original design capacities of the stormwater management facility. The NWPs in Minnesota have a Section 401 certification by the Minnesota Pollution Control Agency issued in a letter dated March 29, 2017 so long as the project meets the conditions listed. This project meets the conditions listed (**Appendix C**).

Appendix A – Figures

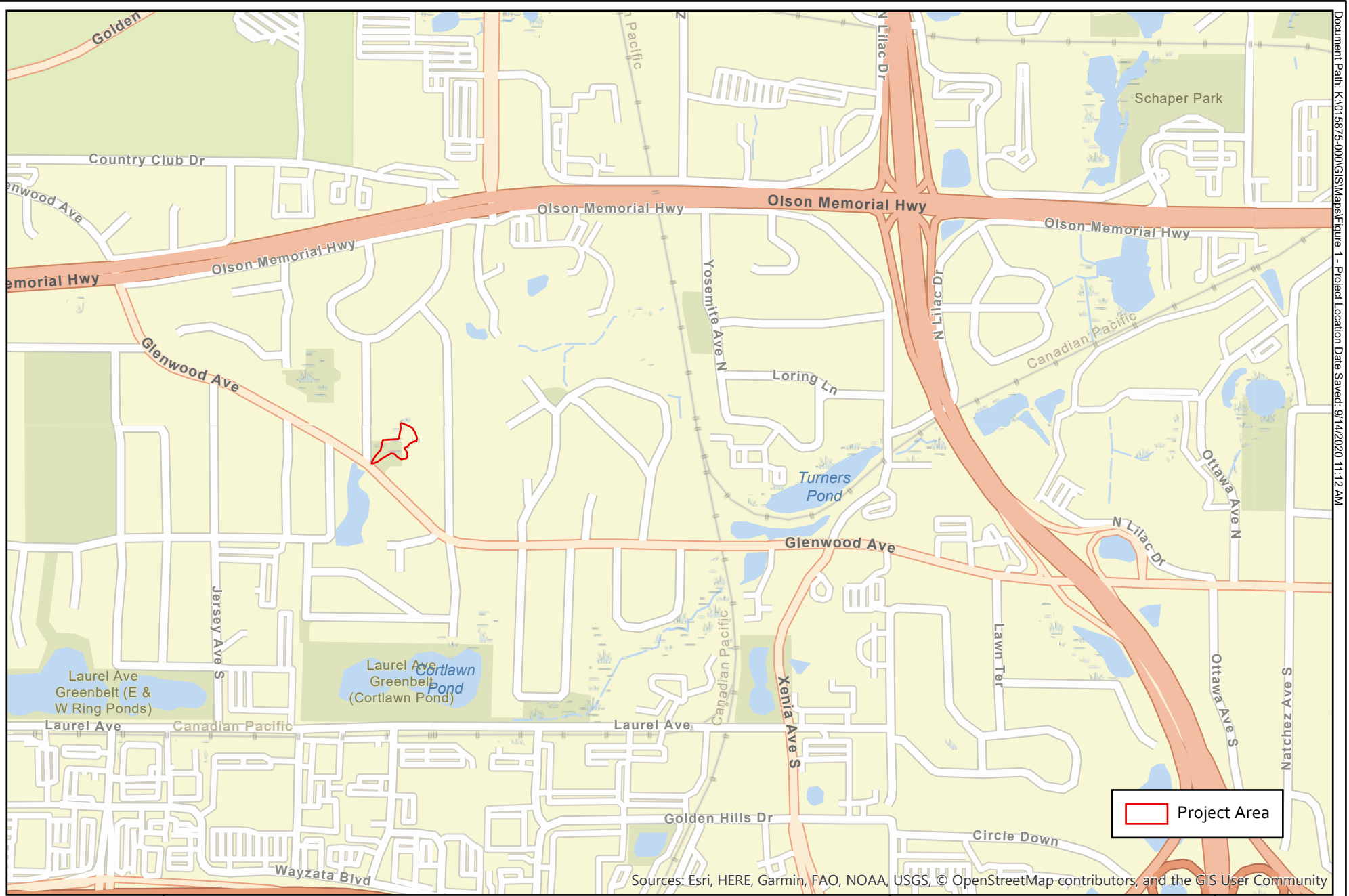

Figure 1: Project Location

The City of Golden Valley
WSB Project No. 015875-000



0 900
Feet
1 inch = 900 feet





Figure 2: 1937 Aerial
The City of Golden Valley
WSB Project No. 015875-000

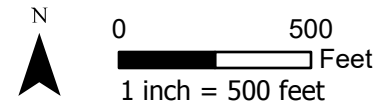

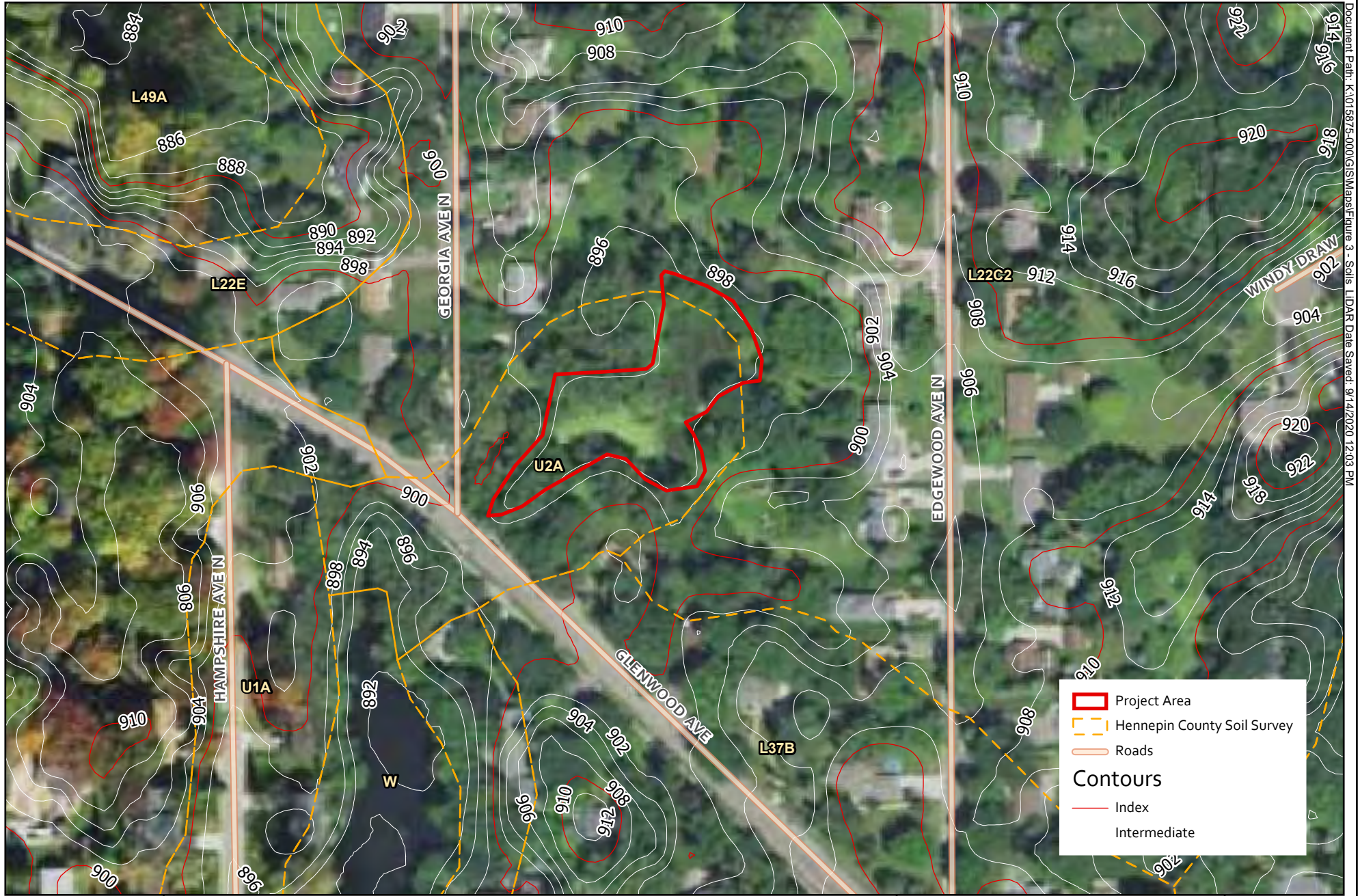
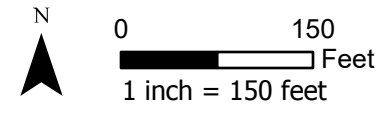

Figure 3: Soils and LiDAR Contours
The City of Golden Valley
WSB Project No. 015875-000



Appendix B – Plans

2020 POND MAINTENANCE PROJECT FOR THE CITY OF GOLDEN VALLEY

GOVERNING SPECIFICATIONS

THE 2018 EDITION OF THE MINNESOTA DEPARTMENT OF TRANSPORTATION "STANDARD SPECIFICATIONS FOR CONSTRUCTION" SHALL GOVERN.

ALL TRAFFIC CONTROL DEVICES SHALL CONFORM TO THE LATEST EDITION OF THE MINNESOTA MANUAL ON UNIFORM TRAFFIC CONTROL DEVICES, INCLUDING THE LATEST FIELD MANUAL FOR TEMPORARY TRAFFIC CONTROL ZONE LAYOUTS.

PLAN SET INDEX

Sheet List Table	
SHEET NUMBER	SHEET TITLE
1	TITLE SHEET
2	POND-SL-13 GRADING AND RESTORATION PLAN

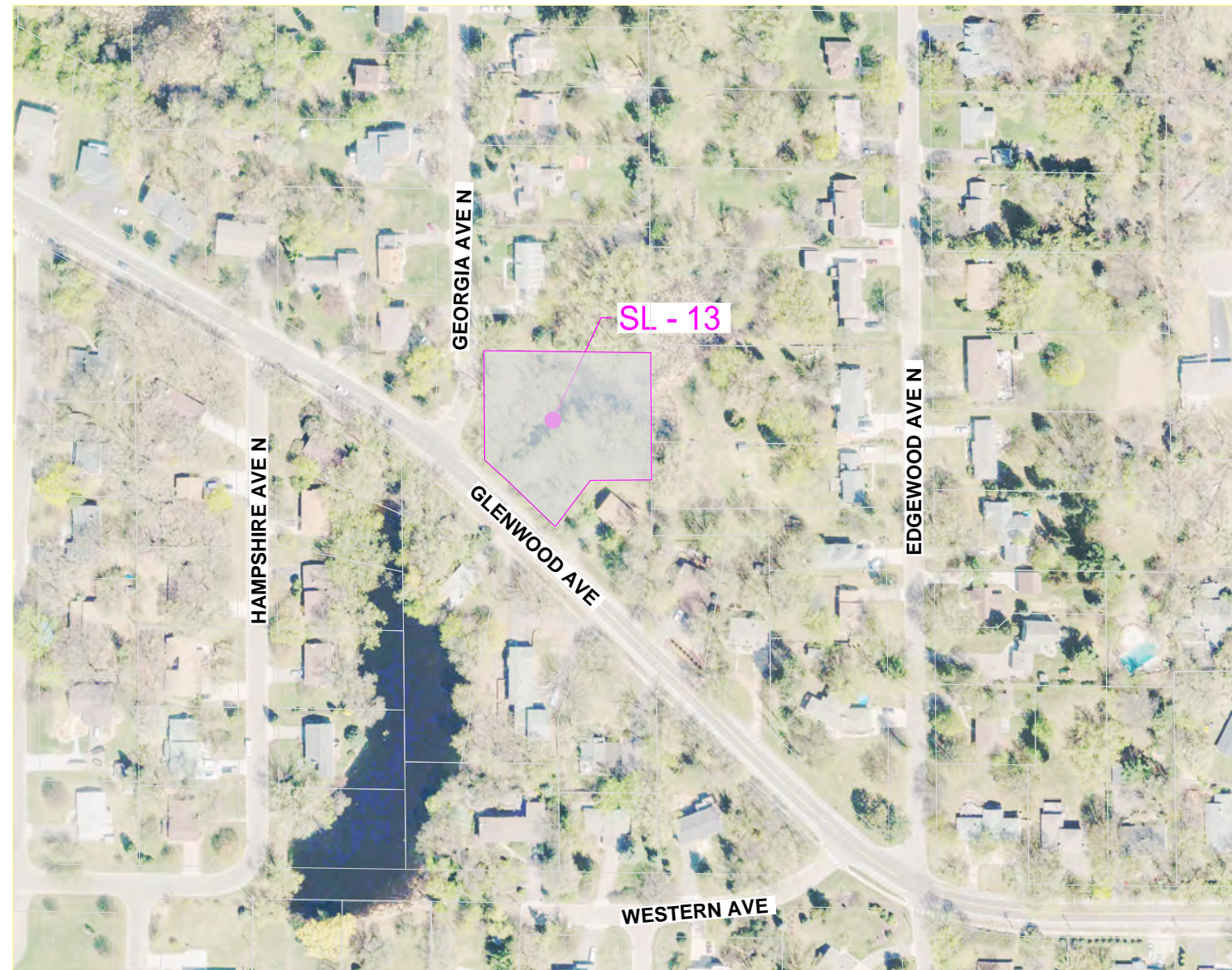

THIS PLAN SET CONTAINS 2 SHEETS

THIS PLAN SET HAS BEEN PREPARED FOR:

CITY OF GOLDEN VALLEY
7800 GOLDEN VALLEY ROAD
GOLDEN VALLEY, MN 55427
(763) 593-8000

ALL APPLICABLE FEDERAL, STATE, AND LOCAL LAWS AND ORDINANCES WILL BE COMPLIED WITH IN THE CONSTRUCTION OF THIS PROJECT.



I HEREBY CERTIFY THAT THIS PLAN WAS PREPARED BY ME OR UNDER MY DIRECT SUPERVISION, AND THAT I AM A DULY LICENSED PROFESSIONAL ENGINEER UNDER THE LAWS OF THE STATE OF MINNESOTA.

JACOB NEWHALL, P.E.

DATE: 09/ /2020

LICENSE NUMBER: 49170

PROJECT LOCATION MAP

EXCAVATION NOTICE SYSTEM

A CALL TO GOPHER STATE ONE (651-454-0002) IS REQUIRED A MINIMUM OF 48 HOURS PRIOR TO PERFORMING ANY EXCAVATION.

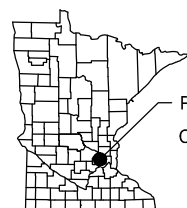

PROJECT LOCATION
COUNTY: HENNEPIN

UTILITY INFORMATION

THE SUBSURFACE UTILITY INFORMATION IN THIS PLAN IS UTILITY QUALITY LEVEL D. THIS UTILITY QUALITY LEVEL WAS DETERMINED ACCORDING TO THE GUIDELINES OF CI/ASCE 38-02, ENTITLED "STANDARD GUIDELINES FOR THE COLLECTION AND DEPICTION OF EXISTING SUBSURFACE UTILITY DATA."

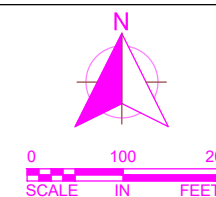









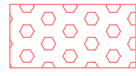
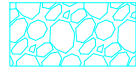

PLAN REVISIONS		
DATE	SHEET NO.	APPROVED BY

WSB PROJ. NO. 015875-000
CITY PROJ. NO. 20-22

SHEET
1
OF
2

LEGEND:

-  PRIMARY STAGING AREA
-  CLEAR AND GRUB WITHIN HATCHED AREA AND AS DIRECTED BY ENGINEER. REMOVAL OF FALLEN TREES IN POND CONSIDERED INCIDENTAL TO POND EXCAVATION BID ITEM.
-  ROCK CONSTRUCTION ENTRANCE. BETWEEN APRIL 15 AND JUNE 1, RESTORE WITH MNDOT SEED MIX 25-131 (220 LBS / AC) AND MNDOT SEED MIX 21-111 (100 LBS / AC) AND EROSION CONTROL BLANKET TYPE 3N
-  CONSTRUCTION LIMITS
-  CONTOUR MAJOR-EXISTING
-  CONTOUR MINOR-EXISTING
-  CONTOUR MAJOR-PROPOSED
-  CONTOUR MINOR-PROPOSED
-  CONTOUR MAJOR-PROPOSED
-  CONTOUR MINOR-PROPOSED
-  EXISTING STORM SEWER
-  INLET PROTECTION
-  ACCESS ROUTE

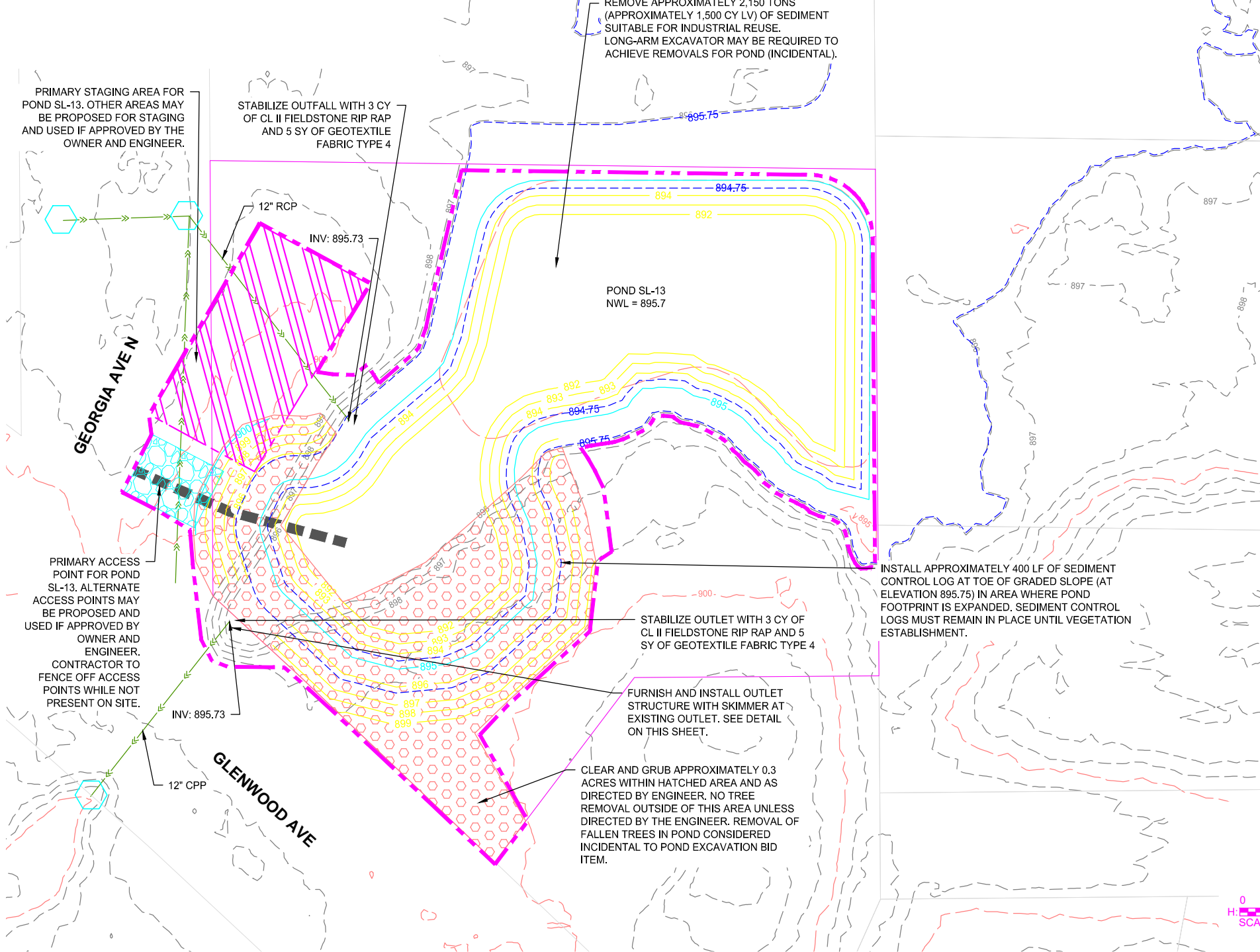

GENERAL CONSTRUCTION NOTES:

1. FOR RESTORATION PERFORMED PRIOR TO APRIL 15, RESTORE ALL DISTURBED AREAS WITH OATS COVER CROP (MNDOT SEED MIX 21-111, 100 LBS / ACRE), STABILIZED WITH MNDOT MULCH TYPE 3. BETWEEN APRIL 15 AND JUNE 1, RESTORE ALL AREAS DISTURBED AS PART OF THE PROJECT WITH SEED MIXES AND EROSION CONTROL AS NOTED IN THE LEGEND.
2. IN THE EVENT THAT RESTORATION CANNOT BE IMPLEMENTED WITHIN 7 DAYS AFTER CONSTRUCTION ACTIVITY IN THE DISTURBED AREA HAS CEASED, TEMPORARY EROSION STABILIZATION BMPs (I.E. HYDRO MULCH 3884.B.2) MUST BE SCHEDULED TO OCCUR WITHIN THAT 7 DAY TIME FRAME.
3. CONTRACTOR RESPONSIBLE FOR THE DAMAGE TO STREETS, CONCRETE CURB AND GUTTER, AND TRAIL.
4. DAILY STREET SWEEPING REQUIRED DURING HAULING OPERATIONS.
5. ALL STOCKPILES MUST HAVE DOWN GRADIENT PERIMETER SEDIMENT CONTROL IMPLEMENTED AND MAINTAINED AT ALL TIMES. STOCKPILES TO RECEIVE TEMPORARY STABILIZATION IF UNWORKED FOR 7 DAYS
6. DEWATERING/DEICING TO TAKE PLACE PRIOR TO EXCAVATION. ICE IS TO BE STOCKPILED WITHIN THE POND DURING EXCAVATION. DEWATERING PLANS MUST BE DEVELOPED IN ACCORDANCE WITH NPDES/MPCA GUIDELINES.
7. CONTRACTOR SHALL PERFORM ALL DEWATERING AND EXCAVATION ONSITE AND OFF OF ROADWAY, AND LOAD AND HAUL OUT USING ACCESS ROUTE.
8. CONTRACTOR TO GRADE AROUND EXISTING STORM SEWER STRUCTURES AS DIRECTED BY THE ENGINEER.
9. CONTRACTOR TO COORDINATE ACCESS LIMITS WITH THE ENGINEER IN THE FIELD.
10. WITHIN PROJECT LIMITS, ALL CLEARING AND/OR GRUBBING OF TREES WITH DIAMETERS LESS THAN 4" AT 4.5' FROM THE GROUND ARE INCIDENTAL TO THE CLEARING AND/OR GRUBBING BID ITEMS.
11. CLEARING AND/OR GRUBBING OF TREES WITH DIAMETERS GREATER THAN 24" WILL BE CONSIDERED AS TWO TREES.
12. EXISTING POND CONTOURS DEVELOPED FROM PRE-DESIGN SURVEY.
13. CONTRACTOR TO PROTECT ALL EXISTING INFRASTRUCTURE INCLUDING PIPES (BURIED AND EXPOSED), FLARED ENDS, AND RETAINING WALLS.
14. CONTRACTOR MUST OBTAIN HENNEPIN COUNTY RIGHT OF WAY PERMIT FOR WORKING WITHIN AND ADJACENT TO GLENWOOD ROAD.
15. BETWEEN APRIL 15 AND JUNE 1, RESTORE BANK AREA WITH NATIVE BUFFER. BUFFER TO BE TEN FEET WIDE AND EXTEND FROM THE NWL (895.7) AND OUT FROM POND. RESTORE BUFFER AREA WITH MNDOT SEED MIX 34-261 (31.5 LBS/AC) AND MNDOT SEED MIX 21-111 (100 LBS/AC) AND EROSION CONTROL BLANKET TYPE 3N.
16. BETWEEN APRIL 15 AND JUNE 1, RESTORE ALL NON-BUFFER AREAS WITH MNDOT SEED MIX 25-131 (220 LBS/AC) AND MNDOT SEED MIX 21-111 (100 LBS/AC) AND EROSION CONTROL BLANKET TYPE 3N.

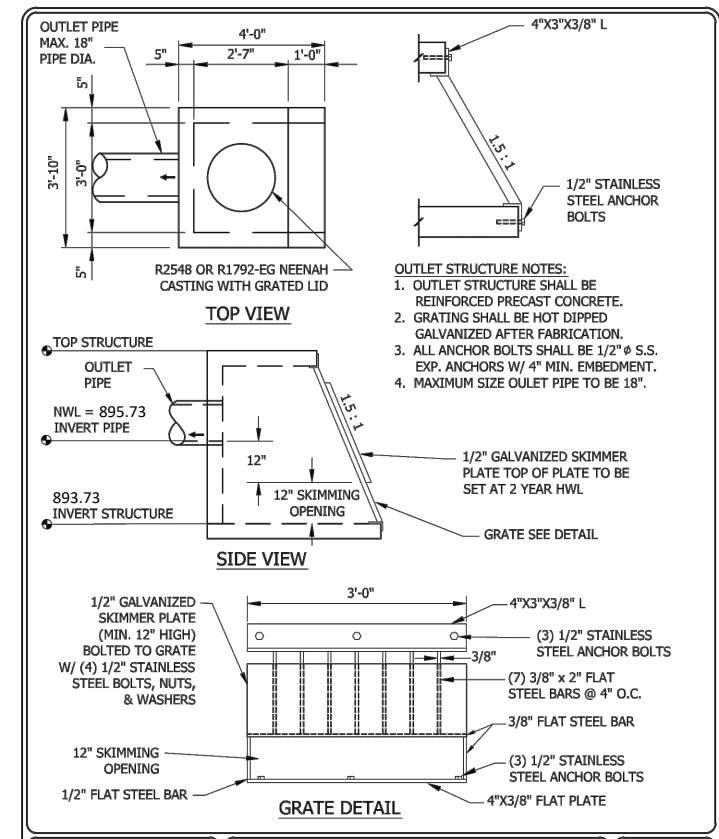

DRAINAGE STRUCTURE DESIGN SPECIAL

REVISIONS

NO.	DATE	DESCRIPTION

I HEREBY CERTIFY THAT THIS PLAN, SPECIFICATION, OR REPORT WAS PREPARED BY ME OR UNDER MY DIRECT SUPERVISION AND THAT I AM A DULY LICENSED PROFESSIONAL ENGINEER UNDER THE LAWS OF THE STATE OF MINNESOTA.

JACOB NEWMALL, P.E.
DATE: 09/20/2020 LIC. NO. 48170

2020 POND MAINTENANCE PROJECT FOR THE CITY OF GOLDEN VALLEY

POND SL - 13 GRADING & RESTORATION PLAN

K:\1015875-000\Cad\Plan\1015875-000-C02-GRD-RSTR.PLAN.dwg 9/24/2020 1:05:19 PM

Appendix C – NWP 43 and Section 401 Certification

Nationwide Permit 43 - Stormwater Management Facilities
Effective Date: March 19, 2017; Expiration Date: March 18, 2022
(NWP Final Notice, 82 FR 1860)

Nationwide Permit 43 - Stormwater Management Facilities. Discharges of dredged or fill material into non-tidal waters of the United States for the construction of stormwater management facilities, including stormwater detention basins and retention basins and other stormwater management facilities; the construction of water control structures, outfall structures and emergency spillways; the construction of low impact development integrated management features such as bioretention facilities (e.g., rain gardens), vegetated filter strips, grassed swales, and infiltration trenches; and the construction of pollutant reduction green infrastructure features designed to reduce inputs of sediments, nutrients, and other pollutants into waters to meet reduction targets established under Total Daily Maximum Loads set under the Clean Water Act.

This NWP authorizes, to the extent that a section 404 permit is required, discharges of dredged or fill material into non-tidal waters of the United States for the maintenance of stormwater management facilities, low impact development integrated management features, and pollutant reduction green infrastructure features. The maintenance of stormwater management facilities, low impact development integrated management features, and pollutant reduction green infrastructure features that are not waters of the United States does not require a section 404 permit.

The discharge must not cause the loss of greater than 1/2-acre of non-tidal waters of the United States. The discharge must not cause the loss of more than 300 linear feet of stream bed, unless for intermittent and ephemeral stream beds the district engineer waives the 300 linear foot limit by making a written determination concluding that the discharge will result in no more than minimal adverse environmental effects. This NWP does not authorize discharges into non-tidal wetlands adjacent to tidal waters. The loss of stream bed plus any other losses of jurisdictional wetlands and waters caused by the NWP activity cannot exceed 1/2-acre. This NWP does not authorize discharges of dredged or fill material for the construction of new stormwater management facilities in perennial streams.

Notification: For discharges into non-tidal waters of the United States for the construction of new stormwater management facilities or pollutant reduction green infrastructure features, or the expansion of existing stormwater management facilities or pollutant reduction green infrastructure features, the permittee must submit a pre-construction notification to the district engineer prior to commencing the activity. (See general condition 32.) Maintenance activities do not require pre-construction notification if they are limited to restoring the original design capacities of the stormwater management facility or pollutant reduction green infrastructure feature. (Authority: Section 404)

A. Nationwide Permit General Conditions

Note: To qualify for NWP authorization, the prospective permittee must comply with the following general conditions, as applicable, in addition to any regional or case-specific conditions imposed by the division engineer or district engineer. Prospective permittees should contact the appropriate Corps district office to determine if regional conditions have been imposed on an NWP. Prospective permittees should also contact the appropriate Corps district office to determine the status of Clean Water Act Section 401 water quality certification and/ or Coastal Zone Management Act consistency for an NWP. Every person who may wish to obtain permit authorization under one or more NWPs, or who is currently relying on an existing or prior permit authorization under one or more NWPs, has been and is on notice that all of the provisions of 33 CFR 330.1 through 330.6 apply to every NWP authorization. Note especially 33 CFR 330.5 relating to the modification, suspension, or revocation of any NWP authorization.

1. **Navigation.** (a) No activity may cause more than a minimal adverse effect on navigation. (b) Any safety lights and signals prescribed by the U.S. Coast Guard, through regulations or otherwise, must be installed and

maintained at the permittee's expense on authorized facilities in navigable waters of the United States. (c) The permittee understands and agrees that, if future operations by the United States require the removal, relocation, or other alteration, of the structure or work herein authorized, or if, in the opinion of the Secretary of the Army or his authorized representative, said structure or work shall cause unreasonable obstruction to the free navigation of the navigable waters, the permittee will be required, upon due notice from the Corps of Engineers, to remove, relocate, or alter the structural work or obstructions caused thereby, without expense to the United States. No claim shall be made against the United States on account of any such removal or alteration.

2. **Aquatic Life Movements.** No activity may substantially disrupt the necessary life cycle movements of those species of aquatic life indigenous to the waterbody, including those species that normally migrate through the area, unless the activity's primary purpose is to impound water. All permanent and temporary crossings of waterbodies shall be suitably culverted, bridged, or otherwise designed and constructed to maintain low flows to sustain the movement of those aquatic species. If a bottomless culvert cannot be used, then the crossing should be designed and constructed to minimize adverse effects to aquatic life movements.
3. **Spawning Areas.** Activities in spawning areas during spawning seasons must be avoided to the maximum extent practicable. Activities that result in the physical destruction (e.g., through excavation, fill, or downstream smothering by substantial turbidity) of an important spawning area are not authorized.
4. **Migratory Bird Breeding Areas.** Activities in waters of the United States that serve as breeding areas for migratory birds must be avoided to the maximum extent practicable.
5. **Shellfish Beds.** No activity may occur in areas of concentrated shellfish populations, unless the activity is directly related to a shellfish harvesting activity authorized by NWPs 4 and 48, or is a shellfish seeding or habitat restoration activity authorized by NWP 27.
6. **Suitable Material.** No activity may use unsuitable material (e.g., trash, debris, car bodies, asphalt, etc.). Material used for construction or discharged must be free from toxic pollutants in toxic amounts (see section 307 of the Clean Water Act).
7. **Water Supply Intakes.** No activity may occur in the proximity of a public water supply intake, except where the activity is for the repair or improvement of public water supply intake structures or adjacent bank stabilization.
8. **Adverse Effects from Impoundments.** If the activity creates an impoundment of water, adverse effects to the aquatic system due to accelerating the passage of water, and/or restricting its flow must be minimized to the maximum extent practicable.
9. **Management of Water Flows.** To the maximum extent practicable, the preconstruction course, condition, capacity, and location of open waters must be maintained for each activity, including stream channelization, storm water management activities, and temporary and permanent road crossings, except as provided below. The activity must be constructed to withstand expected high flows. The activity must not restrict or impede the passage of normal or high flows, unless the primary purpose of the activity is to impound water or manage high flows. The activity may alter the preconstruction course, condition, capacity, and location of open waters if it benefits the aquatic environment (e.g., stream restoration or relocation activities).
10. **Fills Within 100-Year Floodplains.** The activity must comply with applicable FEMA-approved state or local floodplain management requirements.
11. **Equipment.** Heavy equipment working in wetlands or mudflats must be placed on mats, or other measures must be taken to minimize soil disturbance.
12. **Soil Erosion and Sediment Controls.** Appropriate soil erosion and sediment controls must be used and

maintained in effective operating condition during construction, and all exposed soil and other fills, as well as any work below the ordinary high water mark or high tide line, must be permanently stabilized at the earliest practicable date. Permittees are encouraged to perform work within waters of the United States during periods of low-flow or no-flow, or during low tides.

13. **Removal of Temporary Fills.** Temporary fills must be removed in their entirety and the affected areas returned to pre-construction elevations. The affected areas must be revegetated, as appropriate.

14. **Proper Maintenance.** Any authorized structure or fill shall be properly maintained, including maintenance to ensure public safety and compliance with applicable NWP general conditions, as well as any activity-specific conditions added by the district engineer to an NWP authorization.

15. **Single and Complete Project.** The activity must be a single and complete project. The same NWP cannot be used more than once for the same single and complete project.

16. **Wild and Scenic Rivers.**

(a) No NWP activity may occur in a component of the National Wild and Scenic River System, or in a river officially designated by Congress as a "study river" for possible inclusion in the system while the river is in an official study status, unless the appropriate Federal agency with direct management responsibility for such river, has determined in writing that the proposed activity will not adversely affect the Wild and Scenic River designation or study status.

(b) If a proposed NWP activity will occur in a component of the National Wild and Scenic River System, or in a river officially designated by Congress as a "study river" for possible inclusion in the system while the river is in an official study status, the permittee must submit a pre-construction notification (see general condition 32). The district engineer will coordinate the PCN with the Federal agency with direct management responsibility for that river. The permittee shall not begin the NWP activity until notified by the district engineer that the Federal agency with direct management responsibility for that river has determined in writing that the proposed NWP activity will not adversely affect the Wild and Scenic River designation or study status.

(c) Information on Wild and Scenic Rivers may be obtained from the appropriate Federal land management agency responsible for the designated Wild and Scenic River or study river (e.g., National Park Service, U.S. Forest Service, Bureau of Land Management, U.S. Fish and Wildlife Service). Information on these rivers is also available at: <http://www.rivers.gov/>.

17. **Tribal Rights.** No NWP activity may cause more than minimal adverse effects on tribal rights (including treaty rights), protected tribal resources, or tribal lands.

18. **Endangered Species.**

(a) No activity is authorized under any NWP which is likely to directly or indirectly jeopardize the continued existence of a threatened or endangered species or a species proposed for such designation, as identified under the Federal Endangered Species Act (ESA), or which will directly or indirectly destroy or adversely modify the critical habitat of such species. No activity is authorized under any NWP which "may affect" a listed species or critical habitat, unless ESA section 7 consultation addressing the effects of the proposed activity has been completed. Direct effects are the immediate effects on listed species and critical habitat caused by the NWP activity. Indirect effects are those effects on listed species and critical habitat that are caused by the NWP activity and are later in time, but still are reasonably certain to occur.

(b) Federal agencies should follow their own procedures for complying with the requirements of the ESA. If preconstruction notification is required for the proposed activity, the Federal permittee must provide the district engineer with the appropriate documentation to demonstrate compliance with those requirements. The district engineer will verify that the appropriate documentation has been submitted. If the appropriate documentation

has not been submitted, additional ESA section 7 consultation may be necessary for the activity and the respective federal agency would be responsible for fulfilling its obligation under section 7 of the ESA.

(c) Non-federal permittees must submit a pre-construction notification to the district engineer if any listed species or designated critical habitat might be affected or is in the vicinity of the activity, or if the activity is located in designated critical habitat, and shall not begin work on the activity until notified by the district engineer that the requirements of the ESA have been satisfied and that the activity is authorized. For activities that might affect Federally-listed endangered or threatened species or designated critical habitat, the pre-construction notification must include the name(s) of the endangered or threatened species that might be affected by the proposed activity or that utilize the designated critical habitat that might be affected by the proposed activity. The district engineer will determine whether the proposed activity “may affect” or will have “no effect” to listed species and designated critical habitat and will notify the non-Federal applicant of the Corps’ determination within 45 days of receipt of a complete pre-construction notification. In cases where the non-Federal applicant has identified listed species or critical habitat that might be affected or is in the vicinity of the activity, and has so notified the Corps, the applicant shall not begin work until the Corps has provided notification that the proposed activity will have “no effect” on listed species or critical habitat, or until ESA section 7 consultation has been completed. If the non-Federal applicant has not heard back from the Corps within 45 days, the applicant must still wait for notification from the Corps.

(d) As a result of formal or informal consultation with the FWS or NMFS the district engineer may add species-specific permit conditions to the NWP.

(e) Authorization of an activity by an NWP does not authorize the “take” of a threatened or endangered species as defined under the ESA. In the absence of separate authorization (e.g., an ESA Section 10 Permit, a Biological Opinion with “incidental take” provisions, etc.) from the FWS or the NMFS, the Endangered Species Act prohibits any person subject to the jurisdiction of the United States to take a listed species, where “take” means to harass, harm, pursue, hunt, shoot, wound, kill, trap, capture, or collect, or to attempt to engage in any such conduct. The word “harm” in the definition of “take” means an act which actually kills or injures wildlife. Such an act may include significant habitat modification or degradation where it actually kills or injures wildlife by significantly impairing essential behavioral patterns, including breeding, feeding or sheltering.

(f) If the non-federal permittee has a valid ESA section 10(a)(1)(B) incidental take permit with an approved Habitat Conservation Plan for a project or a group of projects that includes the proposed NWP activity, the non-federal applicant should provide a copy of that ESA section 10(a)(1)(B) permit with the PCN required by paragraph (c) of this general condition. The district engineer will coordinate with the agency that issued the ESA section 10(a)(1)(B) permit to determine whether the proposed NWP activity and the associated incidental take were considered in the internal ESA section 7 consultation conducted for the ESA section 10(a)(1)(B) permit. If that coordination results in concurrence from the agency that the proposed NWP activity and the associated incidental take were considered in the internal ESA section 7 consultation for the ESA section 10(a)(1)(B) permit, the district engineer does not need to conduct a separate ESA section 7 consultation for the proposed NWP activity. The district engineer will notify the non-federal applicant within 45 days of receipt of a complete pre-construction notification whether the ESA section 10(a)(1)(B) permit covers the proposed NWP activity or whether additional ESA section 7 consultation is required.

(g) Information on the location of threatened and endangered species and their critical habitat can be obtained directly from the offices of the FWS and NMFS or their world wide Web pages at <http://www.fws.gov/> or <http://www.fws.gov/ipac> and <http://www.nmfs.noaa.gov/pr/species/esa/> respectively.

19. Migratory Birds and Bald and Golden Eagles. The permittee is responsible for ensuring their action complies with the Migratory Bird Treaty Act and the Bald and Golden Eagle Protection Act. The permittee is responsible for contacting appropriate local office of the U.S. Fish and Wildlife Service to determine applicable measures to reduce impacts to migratory birds or eagles, including whether “incidental take” permits are

necessary and available under the Migratory Bird Treaty Act or Bald and Golden Eagle Protection Act for a particular activity.

20. Historic Properties. (a) In cases where the district engineer determines that the activity may have the potential to cause effects to properties listed, or eligible for listing, in the National Register of Historic Places, the activity is not authorized, until the requirements of Section 106 of the National Historic Preservation Act (NHPA) have been satisfied.

(b) Federal permittees should follow their own procedures for complying with the requirements of section 106 of the National Historic Preservation Act. If pre-construction notification is required for the proposed NWP activity, the Federal permittee must provide the district engineer with the appropriate documentation to demonstrate compliance with those requirements. The district engineer will verify that the appropriate documentation has been submitted. If the appropriate documentation is not submitted, then additional consultation under section 106 may be necessary. The respective federal agency is responsible for fulfilling its obligation to comply with section 106.

(c) Non-federal permittees must submit a pre-construction notification to the district engineer if the NWP activity might have the potential to cause effects to any historic properties listed on, determined to be eligible for listing on, or potentially eligible for listing on the National Register of Historic Places, including previously unidentified properties. For such activities, the preconstruction notification must state which historic properties might have the potential to be affected by the proposed NWP activity or include a vicinity map indicating the location of the historic properties or the potential for the presence of historic properties. Assistance regarding information on the location of, or potential for, the presence of historic properties can be sought from the State Historic Preservation Officer, Tribal Historic Preservation Officer, or designated tribal representative, as appropriate, and the National Register of Historic Places (see 33 CFR 330.4(g)). When reviewing pre-construction notifications, district engineers will comply with the current procedures for addressing the requirements of section 106 of the National Historic Preservation Act. The district engineer shall make a reasonable and good faith effort to carry out appropriate identification efforts, which may include background research, consultation, oral history interviews, sample field investigation, and field survey. Based on the information submitted in the PCN and these identification efforts, the district engineer shall determine whether the proposed NWP activity has the potential to cause effects on the historic properties. Section 106 consultation is not required when the district engineer determines that the activity does not have the potential to cause effects on historic properties (see 36 CFR 800.3(a)). Section 106 consultation is required when the district engineer determines that the activity has the potential to cause effects on historic properties. The district engineer will conduct consultation with consulting parties identified under 36 CFR 800.2(c) when he or she makes any of the following effect determinations for the purposes of section 106 of the NHPA: no historic properties affected, no adverse effect, or adverse effect. Where the non-Federal applicant has identified historic properties on which the activity might have the potential to cause effects and so notified the Corps, the non-Federal applicant shall not begin the activity until notified by the district engineer either that the activity has no potential to cause effects to historic properties or that NHPA section 106 consultation has been completed.

(d) For non-federal permittees, the district engineer will notify the prospective permittee within 45 days of receipt of a complete pre-construction notification whether NHPA section 106 consultation is required. If NHPA section 106 consultation is required, the district engineer will notify the non-Federal applicant that he or she cannot begin the activity until section 106 consultation is completed. If the non-Federal applicant has not heard back from the Corps within 45 days, the applicant must still wait for notification from the Corps.

(e) Prospective permittees should be aware that section 110k of the NHPA (54 U.S.C. 306113) prevents the Corps from granting a permit or other assistance to an applicant who, with intent to avoid the requirements of section 106 of the NHPA, has intentionally significantly adversely affected a historic property to which the permit would relate, or having legal power to prevent it, allowed such significant adverse effect to occur, unless the Corps, after consultation with the Advisory Council on Historic Preservation (ACHP), determines that

circumstances justify granting such assistance despite the adverse effect created or permitted by the applicant. If circumstances justify granting the assistance, the Corps is required to notify the ACHP and provide documentation specifying the circumstances, the degree of damage to the integrity of any historic properties affected, and proposed mitigation. This documentation must include any views obtained from the applicant, SHPO/THPO, appropriate Indian tribes if the undertaking occurs on or affects historic properties on tribal lands or affects properties of interest to those tribes, and other parties known to have a legitimate interest in the impacts to the permitted activity on historic properties.

21. Discovery of Previously Unknown Remains and Artifacts. If you discover any previously unknown historic, cultural or archeological remains and artifacts while accomplishing the activity authorized by this permit, you must immediately notify the district engineer of what you have found, and to the maximum extent practicable, avoid construction activities that may affect the remains and artifacts until the required coordination has been completed. The district engineer will initiate the Federal, Tribal, and state coordination required to determine if the items or remains warrant a recovery effort or if the site is eligible for listing in the National Register of Historic Places.

22. Designated Critical Resource Waters. Critical resource waters include, NOAA-managed marine sanctuaries and marine monuments, and National Estuarine Research Reserves. The district engineer may designate, after notice and opportunity for public comment, additional waters officially designated by a state as having particular environmental or ecological significance, such as outstanding national resource waters or state natural heritage sites. The district engineer may also designate additional critical resource waters after notice and opportunity for public comment.

(a) Discharges of dredged or fill material into waters of the United States are not authorized by NWP 7, 12, 14, 16, 17, 21, 29, 31, 35, 39, 40, 42, 43, 44, 49, 50, 51, and 52 for any activity within, or directly affecting, critical resource waters, including wetlands adjacent to such waters.

(b) For NWP 3, 8, 10, 13, 15, 18, 19, 22, 23, 25, 27, 28, 30, 33, 34, 36, 37, 38, and 54, notification is required in accordance with general condition 32, for any activity proposed in the designated critical resource waters including wetlands adjacent to those waters. The district engineer may authorize activities under these NWPs only after it is determined that the impacts to the critical resource waters will be no more than minimal.

23. Mitigation. The district engineer will consider the following factors when determining appropriate and practicable mitigation necessary to ensure that the individual and cumulative adverse environmental effects are no more than minimal:

(a) The activity must be designed and constructed to avoid and minimize adverse effects, both temporary and permanent, to waters of the United States to the maximum extent practicable at the project site (i.e., on site).

(b) Mitigation in all its forms (avoiding, minimizing, rectifying, reducing, or compensating for resource losses) will be required to the extent necessary to ensure that the individual and cumulative adverse environmental effects are no more than minimal.

(c) Compensatory mitigation at a minimum one-for-one ratio will be required for all wetland losses that exceed 1/10-acre and require preconstruction notification, unless the district engineer determines in writing that either some other form of mitigation would be more environmentally appropriate or the adverse environmental effects of the proposed activity are no more than minimal, and provides an activity-specific waiver of this requirement. For wetland losses of 1/10-acre or less that require preconstruction notification, the district engineer may determine on a case-by-case basis that compensatory mitigation is required to ensure that the activity results in only minimal adverse environmental effects.

(d) For losses of streams or other open waters that require pre-construction notification, the district engineer

may require compensatory mitigation to ensure that the activity results in no more than minimal adverse environmental effects. Compensatory mitigation for losses of streams should be provided, if practicable, through stream rehabilitation, enhancement, or preservation, since streams are difficult to-replace resources (see 33 CFR 332.3(e)(3)).

(e) Compensatory mitigation plans for NWP activities in or near streams or other open waters will normally include a requirement for the restoration or enhancement, maintenance, and legal protection (e.g., conservation easements) of riparian areas next to open waters. In some cases, the restoration or maintenance/protection of riparian areas may be the only compensatory mitigation required. Restored riparian areas should consist of native species. The width of the required riparian area will address documented water quality or aquatic habitat loss concerns. Normally, the riparian area will be 25 to 50 feet wide on each side of the stream, but the district engineer may require slightly wider riparian areas to address documented water quality or habitat loss concerns. If it is not possible to restore or maintain/protect a riparian area on both sides of a stream, or if the waterbody is a lake or coastal waters, then restoring or maintaining/protecting a riparian area along a single bank or shoreline may be sufficient. Where both wetlands and open waters exist on the project site, the district engineer will determine the appropriate compensatory mitigation (e.g., riparian areas and/or wetlands compensation) based on what is best for the aquatic environment on a watershed basis. In cases where riparian areas are determined to be the most appropriate form of minimization or compensatory mitigation, the district engineer may waive or reduce the requirement to provide wetland compensatory mitigation for wetland losses.

(f) Compensatory mitigation projects provided to offset losses of aquatic resources must comply with the applicable provisions of 33 CFR part 332.

(1) The prospective permittee is responsible for proposing an appropriate compensatory mitigation option if compensatory mitigation is necessary to ensure that the activity results in no more than minimal adverse environmental effects. For the NWPs, the preferred mechanism for providing compensatory mitigation is mitigation bank credits or in-lieu fee program credits (see 33 CFR 332.3(b)(2) and (3)). However, if an appropriate number and type of mitigation bank or in-lieu credits are not available at the time the PCN is submitted to the district engineer, the district engineer may approve the use of permittee-responsible mitigation.

(2) The amount of compensatory mitigation required by the district engineer must be sufficient to ensure that the authorized activity results in no more than minimal individual and cumulative adverse environmental effects (see 33 CFR 330.1(e)(3)). (See also 33 CFR 332.3(f)).

(3) Since the likelihood of success is greater and the impacts to potentially valuable uplands are reduced, aquatic resource restoration should be the first compensatory mitigation option considered for permittee-responsible mitigation.

(4) If permittee-responsible mitigation is the proposed option, the prospective permittee is responsible for submitting a mitigation plan. A conceptual or detailed mitigation plan may be used by the district engineer to make the decision on the NWP verification request, but a final mitigation plan that addresses the applicable requirements of 33 CFR 332.4(c)(2) through (14) must be approved by the district engineer before the permittee begins work in waters of the United States, unless the district engineer determines that prior approval of the final mitigation plan is not practicable or not necessary to ensure timely completion of the required compensatory mitigation (see 33 CFR 332.3(k)(3)).

(5) If mitigation bank or in-lieu fee program credits are the proposed option, the mitigation plan only needs to address the baseline conditions at the impact site and the number of credits to be provided.

(6) Compensatory mitigation requirements (e.g., resource type and amount to be provided as compensatory mitigation, site protection, ecological performance standards, monitoring requirements) may be addressed through conditions added to the NWP authorization, instead of components of a compensatory mitigation plan

(see 33 CFR 332.4(c)(1)(ii)).

(g) Compensatory mitigation will not be used to increase the acreage losses allowed by the acreage limits of the NWP. For example, if an NWP has an acreage limit of 1/2-acre, it cannot be used to authorize any NWP activity resulting in the loss of greater than 1/2- acre of waters of the United States, even if compensatory mitigation is provided that replaces or restores some of the lost waters. However, compensatory mitigation can and should be used, as necessary, to ensure that an NWP activity already meeting the established acreage limits also satisfies the no more than minimal impact requirement for the NWPs.

(h) Permittees may propose the use of mitigation banks, in-lieu fee programs, or permittee- responsible mitigation. When developing a compensatory mitigation proposal, the permittee must consider appropriate and practicable options consistent with the framework at 33 CFR 332.3(b). For activities resulting in the loss of marine or estuarine resources, permittee responsible mitigation may be environmentally preferable if there are no mitigation banks or in- lieu fee programs in the area that have marine or estuarine credits available for sale or transfer to the permittee. For permittee responsible mitigation, the special conditions of the NWP verification must clearly indicate the party or parties responsible for the implementation and performance of the compensatory mitigation project, and, if required, its long-term management.

(i) Where certain functions and services of waters of the United States are permanently adversely affected by a regulated activity, such as discharges of dredged or fill material into waters of the United States that will convert a forested or scrub-shrub wetland to a herbaceous wetland in a permanently maintained utility line right-of-way, mitigation may be required to reduce the adverse environmental effects of the activity to the no more than minimal level.

24. Safety of Impoundment Structures. To ensure that all impoundment structures are safely designed, the district engineer may require non-Federal applicants to demonstrate that the structures comply with established state dam safety criteria or have been designed by qualified persons. The district engineer may also require documentation that the design has been independently reviewed by similarly qualified persons, and appropriate modifications made to ensure safety.

25. Water Quality. Where States and authorized Tribes, or EPA where applicable, have not previously certified compliance of an NWP with CWA section 401, individual 401 Water Quality Certification must be obtained or waived (see 33 CFR 330.4(c)). The district engineer or State or Tribe may require additional water quality management measures to ensure that the authorized activity does not result in more than minimal degradation of water quality.

26. Coastal Zone Management. In coastal states where an NWP has not previously received a state coastal zone management consistency concurrence, an individual state coastal zone management consistency concurrence must be obtained, or a presumption of concurrence must occur (see 33 CFR 330.4(d)). The district engineer or a State may require additional measures to ensure that the authorized activity is consistent with state coastal zone management requirements.

27. Regional and Case-By-Case Conditions. The activity must comply with any regional conditions that may have been added by the Division Engineer (see 33 CFR 330.4(e)) and with any case specific conditions added by the Corps or by the state, Indian Tribe, or U.S. EPA in its section 401 Water Quality Certification, or by the state in its Coastal Zone Management Act consistency determination.

28. Use of Multiple Nationwide Permits. Use of Multiple Nationwide Permits. The use of more than one NWP for a single and complete project is prohibited, except when the acreage loss of waters of the United States authorized by the NWPs does not exceed the acreage limit of the NWP with the highest specified acreage limit. For example, if a road crossing over tidal waters is constructed under NWP 14, with associated bank stabilization authorized by NWP 13, the maximum acreage loss of waters of the United States for the total project cannot

exceed 1/3- acre.

29. Transfer of Nationwide Permit Verifications. If the permittee sells the property associated with a nationwide permit verification, the permittee may transfer the nationwide permit verification to the new owner by submitting a letter to the appropriate Corps district office to validate the transfer. A copy of the nationwide permit verification must be attached to the letter, and the letter must contain the following statement and signature:

“When the structures or work authorized by this nationwide permit are still in existence at the time the property is transferred, the terms and conditions of this nationwide permit, including any special conditions, will continue to be binding on the new owner(s) of the property. To validate the transfer of this nationwide permit and the associated liabilities associated with compliance with its terms and conditions, have the transferee sign and date below.”

(Transferee)

(Date)

30. Compliance Certification. Each permittee who receives an NWP verification letter from the Corps must provide a signed certification documenting completion of the authorized activity and implementation of any required compensatory mitigation. The success of any required permittee-responsible mitigation, including the achievement of ecological performance standards, will be addressed separately by the district engineer. The Corps will provide the permittee the certification document with the NWP verification letter. The certification document will include:

(a) A statement that the authorized activity was done in accordance with the NWP authorization, including any general, regional, or activity-specific conditions;

(b) A statement that the implementation of any required compensatory mitigation was completed in accordance with the permit conditions. If credits from a mitigation bank or in-lieu fee program are used to satisfy the compensatory mitigation requirements, the certification must include the documentation required by 33 CFR 332.3(l)(3) to confirm that the permittee secured the appropriate number and resource type of credits; and

(c) The signature of the permittee certifying the completion of the activity and mitigation. The completed certification document must be submitted to the district engineer within 30 days of completion of the authorized activity or the implementation of any required compensatory mitigation, whichever occurs later.

31. Activities Affecting Structures or Works Built by the United States. If an NWP activity also requires permission from the Corps pursuant to 33 U.S.C. 408 because it will alter or temporarily or permanently occupy or use a U.S. Army Corps of Engineers (USACE) federally authorized Civil Works project (a “USACE project”), the prospective permittee must submit a preconstruction notification. See paragraph (b)(10) of general condition 32. An activity that requires section 408 permission is not authorized by NWP until the appropriate Corps office issues the section 408 permission to alter, occupy, or use the USACE project, and the district engineer issues a written NWP verification.

32. Pre-Construction Notification. (a) Timing. Where required by the terms of the NWP, the prospective permittee must notify the district engineer by submitting a pre-construction notification (PCN) as early as possible. The district engineer must determine if the PCN is complete within 30 calendar days of the date of receipt and, if the PCN is determined to be incomplete, notify the prospective permittee within that 30 day period to request the additional information necessary to make the PCN complete. The request must specify the information needed to make the PCN complete. As a general rule, district engineers will request additional information necessary to make the PCN complete only once. However, if the prospective permittee does not provide all of the requested information, then the district engineer will notify the prospective permittee that the PCN is still incomplete and the PCN review process will not commence until all of the requested information has been received by the district engineer. The prospective permittee shall not begin the activity until either:

(1) He or she is notified in writing by the district engineer that the activity may proceed under the NWP with any special conditions imposed by the district or division engineer; or

(2) 45 calendar days have passed from the district engineer's receipt of the complete PCN and the prospective permittee has not received written notice from the district or division engineer. However, if the permittee was required to notify the Corps pursuant to general condition 18 that listed species or critical habitat might be affected or are in the vicinity of the activity, or to notify the Corps pursuant to general condition 20 that the activity might have the potential to cause effects to historic properties, the permittee cannot begin the activity until receiving written notification from the Corps that there is "no effect" on listed species or "no potential to cause effects" on historic properties, or that any consultation required under Section 7 of the Endangered Species Act (see 33 CFR 330.4(f)) and/or section 106 of the National Historic Preservation Act (see 33 CFR 330.4(g)) has been completed. Also, work cannot begin under NWPs 21, 49, or 50 until the permittee has received written approval from the Corps. If the proposed activity requires a written waiver to exceed specified limits of an NWP, the permittee may not begin the activity until the district engineer issues the waiver. If the district or division engineer notifies the permittee in writing that an individual permit is required within 45 calendar days of receipt of a complete PCN, the permittee cannot begin the activity until an individual permit has been obtained. Subsequently, the permittee's right to proceed under the NWP may be modified, suspended, or revoked only in accordance with the procedure set forth in 33 CFR 330.5(d)(2).

(b) Contents of Pre-Construction Notification: The PCN must be in writing and include the following information:

(1) Name, address and telephone numbers of the prospective permittee;

(2) Location of the proposed activity;

(3) Identify the specific NWP or NWP(s) the prospective permittee wants to use to authorize the proposed activity;

(4) A description of the proposed activity; the activity's purpose; direct and indirect adverse environmental effects the activity would cause, including the anticipated amount of loss of wetlands, other special aquatic sites, and other waters expected to result from the NWP activity, in acres, linear feet, or other appropriate unit of measure; a description of any proposed mitigation measures intended to reduce the adverse environmental effects caused by the proposed activity; and any other NWP(s), regional general permit(s), or individual permit(s) used or intended to be used to authorize any part of the proposed project or any related activity, including other separate and distant crossings for linear projects that require Department of the Army authorization but do not require pre-construction notification. The description of the proposed activity and any proposed mitigation measures should be sufficiently detailed to allow the district engineer to determine that the adverse environmental effects of the activity will be no more than minimal and to determine the need for compensatory mitigation or other mitigation measures. For single and complete linear projects, the PCN must include the quantity of anticipated losses of wetlands, other special aquatic sites, and other waters for each single and complete crossing of those wetlands,

other special aquatic sites, and other waters. Sketches should be provided when necessary to show that the activity complies with the terms of the NWP. (Sketches usually clarify the activity and when provided results in a quicker decision. Sketches should contain sufficient detail to provide an illustrative description of the proposed activity (e.g., a conceptual plan), but do not need to be detailed engineering plans);

(5) The PCN must include a delineation of wetlands, other special aquatic sites, and other waters, such as lakes and ponds, and perennial, intermittent, and ephemeral streams, on the project site. Wetland delineations must be prepared in accordance with the current method required by the Corps. The permittee may ask the Corps to delineate the special aquatic sites and other waters on the project site, but there may be a delay if the Corps does the delineation, especially if the project site is large or contains many wetlands, other special aquatic sites, and other waters. Furthermore, the 45 day period will not start until the delineation has been submitted to or completed by the Corps, as appropriate;

(6) If the proposed activity will result in the loss of greater than 1/10-acre of wetlands and a PCN is required, the prospective permittee must submit a statement describing how the mitigation requirement will be satisfied, or explaining why the adverse environmental effects are no more than minimal and why compensatory mitigation should not be required. As an alternative, the prospective permittee may submit a conceptual or detailed mitigation plan.

(7) For non-Federal permittees, if any listed species or designated critical habitat might be affected or is in the vicinity of the activity, or if the activity is located in designated critical habitat, the PCN must include the name(s) of those endangered or threatened species that might be affected by the proposed activity or utilize the designated critical habitat that might be affected by the proposed activity. For NWP activities that require pre-construction notification, Federal permittees must provide documentation demonstrating compliance with the Endangered Species Act;

(8) For non-Federal permittees, if the NWP activity might have the potential to cause effects to a historic property listed on, determined to be eligible for listing on, or potentially eligible for listing on, the National Register of Historic Places, the PCN must state which historic property might have the potential to be affected by the proposed activity or include a vicinity map indicating the location of the historic property. For NWP activities that require pre-construction notification, Federal permittees must provide documentation demonstrating compliance with section 106 of the National Historic Preservation Act;

(9) For an activity that will occur in a component of the National Wild and Scenic River System, or in a river officially designated by Congress as a "study river" for possible inclusion in the system while the river is in an official study status, the PCN must identify the Wild and Scenic River or the "study river" (see general condition 16); and

(10) For an activity that requires permission from the Corps pursuant to 33 U.S.C. 408 because it will alter or temporarily or permanently occupy or use a U.S. Army Corps of Engineers federally authorized civil works project, the pre-construction notification must include a statement confirming that the project proponent has submitted a written request for section 408 permission from the Corps office having jurisdiction over that USACE project.

(c) Form of Pre-Construction Notification: The standard individual permit application form (Form ENG 4345) may be used, but the completed application form must clearly indicate that it is an NWP PCN and must include all of the applicable information required in paragraphs (b)(1) through (10) of this general condition. A letter containing the required information may also be used. Applicants may provide electronic files of PCNs and supporting materials if the district engineer has established tools and procedures for electronic submittals.

(d) Agency Coordination: (1) The district engineer will consider any comments from Federal and state agencies

concerning the proposed activity's compliance with the terms and conditions of the NWP's and the need for mitigation to reduce the activity's adverse environmental effects so that they are no more than minimal.

(2) Agency coordination is required for: (i) All NWP activities that require pre-construction notification and result in the loss of greater than 1/2-acre of waters of the United States; (ii) NWP 21, 29, 39, 40, 42, 43, 44, 50, 51, and 52 activities that require pre-construction notification and will result in the loss of greater than 300 linear feet of stream bed; (iii) NWP 13 activities in excess of 500 linear feet, fills greater than one cubic yard per running foot, or involve discharges of dredged or fill material into special aquatic sites; and (iv) NWP 54 activities in excess of 500 linear feet, or that extend into the waterbody more than 30 feet from the mean low water line in tidal waters or the ordinary high water mark in the Great Lakes.

(3) When agency coordination is required, the district engineer will immediately provide (e.g., via email, facsimile transmission, overnight mail, or other expeditious manner) a copy of the complete PCN to the appropriate Federal or state offices (FWS, state natural resource or water quality agency, EPA, and, if appropriate, the NMFS). With the exception of NWP 37, these agencies will have 10 calendar days from the date the material is transmitted to notify the district engineer via telephone, facsimile transmission, or email that they intend to provide substantive, site-specific comments. The comments must explain why the agency believes the adverse environmental effects will be more than minimal. If so contacted by an agency, the district engineer will wait an additional 15 calendar days before making a decision on the preconstruction notification. The district engineer will fully consider agency comments received within the specified time frame concerning the proposed activity's compliance with the terms and conditions of the NWP's, including the need for mitigation to ensure the net adverse environmental effects of the proposed activity are no more than minimal. The district engineer will provide no response to the resource agency, except as provided below. The district engineer will indicate in the administrative record associated with each pre-construction notification that the resource agencies' concerns were considered. For NWP 37, the emergency watershed protection and rehabilitation activity may proceed immediately in cases where there is an unacceptable hazard to life or a significant loss of property or economic hardship will occur. The district engineer will consider any comments received to decide whether the NWP 37 authorization should be modified, suspended, or revoked in accordance with the procedures at 33 CFR 330.5.

(4) In cases of where the prospective permittee is not a Federal agency, the district engineer will provide a response to NMFS within 30 calendar days of receipt of any Essential Fish Habitat conservation recommendations, as required by section 305(b)(4)(B) of the Magnuson-Stevens Fishery Conservation and Management Act.

(5) Applicants are encouraged to provide the Corps with either electronic files or multiple copies of preconstruction notifications to expedite agency coordination.

B. District Engineer's Decision.

1. In reviewing the PCN for the proposed activity, the district engineer will determine whether the activity authorized by the NWP will result in more than minimal individual or cumulative adverse environmental effects or may be contrary to the public interest. If a project proponent requests authorization by a specific NWP, the district engineer should issue the NWP verification for that activity if it meets the terms and conditions of that NWP, unless he or she determines, after considering mitigation, that the proposed activity will result in more than minimal individual and cumulative adverse effects on the aquatic environment and other aspects of the public interest and exercises discretionary authority to require an individual permit for the proposed activity. For a linear project, this determination will include an evaluation of the individual crossings of waters of the United States to determine whether they individually satisfy the terms and conditions of the NWP(s), as well as the cumulative effects caused by all of the crossings authorized by NWP. If an applicant requests a waiver of the 300 linear foot limit on impacts to streams or of an otherwise applicable limit, as provided for in NWP's 13, 21, 29, 36, 39, 40, 42, 43, 44, 50, 51, 52, or 54, the district engineer will only grant the waiver upon a written determination that the NWP activity will result in only minimal individual and cumulative adverse environmental effects. For those NWP's that

have a waivable 300 linear foot limit for losses of intermittent and ephemeral stream bed and a 1/2-acre limit (i.e., NWP 21, 29, 39, 40, 42, 43, 44, 50, 51, and 52), the loss of intermittent and ephemeral stream bed, plus any other losses of jurisdictional waters and wetlands, cannot exceed 1/2- acre.

2. When making minimal adverse environmental effects determinations the district engineer will consider the direct and indirect effects caused by the NWP activity. He or she will also consider the cumulative adverse environmental effects caused by activities authorized by NWP and whether those cumulative adverse environmental effects are no more than minimal. The district engineer will also consider site specific factors, such as the environmental setting in the vicinity of the NWP activity, the type of resource that will be affected by the NWP activity, the functions provided by the aquatic resources that will be affected by the NWP activity, the degree or magnitude to which the aquatic resources perform those functions, the extent that aquatic resource functions will be lost as a result of the NWP activity (e.g., partial or complete loss), the duration of the adverse effects (temporary or permanent), the importance of the aquatic resource functions to the region (e.g., watershed or ecoregion), and mitigation required by the district engineer. If an appropriate functional or condition assessment method is available and practicable to use, that assessment method may be used by the district engineer to assist in the minimal adverse environmental effects determination. The district engineer may add case-specific special conditions to the NWP authorization to address site-specific environmental concerns.

3. If the proposed activity requires a PCN and will result in a loss of greater than 1/10-acre of wetlands, the prospective permittee should submit a mitigation proposal with the PCN. Applicants may also propose compensatory mitigation for NWP activities with smaller impacts, or for impacts to other types of waters (e.g., streams). The district engineer will consider any proposed compensatory mitigation or other mitigation measures the applicant has included in the proposal in determining whether the net adverse environmental effects of the proposed activity are no more than minimal. The compensatory mitigation proposal may be either conceptual or detailed. If the district engineer determines that the activity complies with the terms and conditions of the NWP and that the adverse environmental effects are no more than minimal, after considering mitigation, the district engineer will notify the permittee and include any activity specific conditions in the NWP verification the district engineer deems necessary. Conditions for compensatory mitigation requirements must comply with the appropriate provisions at 33 CFR 332.3(k). The district engineer must approve the final mitigation plan before the permittee commences work in waters of the United States, unless the district engineer determines that prior approval of the final mitigation plan is not practicable or not necessary to ensure timely completion of the required compensatory mitigation. If the prospective permittee elects to submit a compensatory mitigation plan with the PCN, the district engineer will expeditiously review the proposed compensatory mitigation plan. The district engineer must review the proposed compensatory mitigation plan within 45 calendar days of receiving a complete PCN and determine whether the proposed mitigation would ensure the NWP activity results in no more than minimal adverse environmental effects. If the net adverse environmental effects of the NWP activity (after consideration of the mitigation proposal) are determined by the district engineer to be no more than minimal, the district engineer will provide a timely written response to the applicant. The response will state that the NWP activity can proceed under the terms and conditions of the NWP, including any activity-specific conditions added to the NWP authorization by the district engineer.

4. If the district engineer determines that the adverse environmental effects of the proposed activity are more than minimal, then the district engineer will notify the applicant either: (a) That the activity does not qualify for authorization under the NWP and instruct the applicant on the procedures to seek authorization under an individual permit; (b) that the activity is authorized under the NWP subject to the applicant's submission of a mitigation plan that would reduce the adverse environmental effects so that they are no more than minimal; or (c) that the activity is authorized under the NWP with specific modifications or conditions. Where the district engineer determines that mitigation is required to ensure no more than minimal adverse environmental effects, the activity will be authorized within the 45-day PCN period (unless additional time is required to comply with general conditions 18, 20, and/or 31, or to evaluate PCNs for activities authorized by NWPs 21, 49, and 50), with activity specific conditions that state the mitigation requirements. The authorization will include the necessary conceptual or detailed mitigation plan or a requirement that the applicant submit a mitigation plan that would reduce the

adverse environmental effects so that they are no more than minimal. When compensatory mitigation is required, no work in waters of the United States may occur until the district engineer has approved a specific mitigation plan or has determined that prior approval of a final mitigation plan is not practicable or not necessary to ensure timely completion of the required compensatory mitigation.

C. Further Information

1. District Engineers have authority to determine if an activity complies with the terms and conditions of an NWP.
2. NWPs do not obviate the need to obtain other federal, state, or local permits, approvals, or authorizations required by law.
3. NWPs do not grant any property rights or exclusive privileges.
4. NWPs do not authorize any injury to the property or rights of others.
5. NWPs do not authorize interference with any existing or proposed Federal project (see general condition 31).

D. Definitions

Best management practices (BMPs): Policies, practices, procedures, or structures implemented to mitigate the adverse environmental effects on surface water quality resulting from development. BMPs are categorized as structural or non-structural.

Compensatory mitigation: The restoration (re-establishment or rehabilitation), establishment (creation), enhancement, and/or in certain circumstances preservation of aquatic resources for the purposes of offsetting unavoidable adverse impacts which remain after all appropriate and practicable avoidance and minimization has been achieved.

Currently serviceable: Useable as is or with some maintenance, but not so degraded as to essentially require reconstruction.

Direct effects: Effects that are caused by the activity and occur at the same time and place.

Discharge: The term “discharge” means any discharge of dredged or fill material into waters of the United States.

Ecological reference: A model used to plan and design an aquatic habitat and riparian area restoration, enhancement, or establishment activity under NWP 27. An ecological reference may be based on the structure, functions, and dynamics of an aquatic habitat type or a riparian area type that currently exists in the region where the proposed NWP 27 activity is located. Alternatively, an ecological reference may be based on a conceptual model for the aquatic habitat type or riparian area type to be restored, enhanced, or established as a result of the proposed NWP 27 activity. An ecological reference takes into account the range of variation of the aquatic habitat type or riparian area type in the region.

Enhancement: The manipulation of the physical, chemical, or biological characteristics of an aquatic resource to heighten, intensify, or improve a specific aquatic resource function(s). Enhancement results in the gain of selected aquatic resource function(s), but may also lead to a decline in other aquatic resource function(s). Enhancement does not result in a gain in aquatic resource area.

Ephemeral stream: An ephemeral stream has flowing water only during, and for a short duration after, precipitation events in a typical year. Ephemeral stream beds are located above the water table year-round. Groundwater is not a source of water for the stream. Runoff from rainfall is the primary source of water for stream flow.

Establishment (creation): The manipulation of the physical, chemical, or biological characteristics present to develop an aquatic resource that did not previously exist at an upland site. Establishment results in a gain in aquatic resource area.

High Tide Line: The line of intersection of the land with the water's surface at the maximum height reached by a rising tide. The high tide line may be determined, in the absence of actual data, by a line of oil or scum along shore objects, a more or less continuous deposit of fine shell or debris on the foreshore or berm, other physical markings or characteristics, vegetation lines, tidal gages, or other suitable means that delineate the general height reached by a rising tide. The line encompasses spring high tides and other high tides that occur with periodic frequency but does not include storm surges in which there is a departure from the normal or predicted reach of the tide due to the piling up of water against a coast by strong winds such as those accompanying a hurricane or other intense storm.

Historic Property: Any prehistoric or historic district, site (including archaeological site), building, structure, or other object included in, or eligible for inclusion in, the National Register of Historic Places maintained by the Secretary of the Interior. This term includes artifacts, records, and remains that are related to and located within such properties. The term includes properties of traditional religious and cultural importance to an Indian tribe or Native Hawaiian organization and that meet the National Register criteria (36 CFR part 60).

Independent utility: A test to determine what constitutes a single and complete non-linear project in the Corps Regulatory Program. A project is considered to have independent utility if it would be constructed absent the construction of other projects in the project area. Portions of a multi-phase project that depend upon other phases of the project do not have independent utility. Phases of a project that would be constructed even if the other phases were not built can be considered as separate single and complete projects with independent utility.

Indirect effects: Effects that are caused by the activity and are later in time or farther removed in distance, but are still reasonably foreseeable.

Intermittent stream: An intermittent stream has flowing water during certain times of the year, when groundwater provides water for stream flow. During dry periods, intermittent streams may not have flowing water. Runoff from rainfall is a supplemental source of water for stream flow.

Loss of waters of the United States: Waters of the United States that are permanently adversely affected by filling, flooding, excavation, or drainage because of the regulated activity. Permanent adverse effects include permanent discharges of dredged or fill material that change an aquatic area to dry land, increase the bottom elevation of a waterbody, or change the use of a waterbody. The acreage of loss of waters of the United States is a threshold measurement of the impact to jurisdictional waters for determining whether a project may qualify for an NWP; it is not a net threshold that is calculated after considering compensatory mitigation that may be used to offset losses of aquatic functions and services. The loss of stream bed includes the acres or linear feet of stream bed that are filled or excavated as a result of the regulated activity. Waters of the United States temporarily filled, flooded, excavated, or drained, but restored to pre-construction contours and elevations after construction, are not included in the measurement of loss of waters of the United States. Impacts resulting from activities that do not require Department of the Army authorization, such as activities eligible for exemptions under section 404(f) of the Clean Water Act, are not considered when calculating the loss of waters of the United States.

Navigable waters: Waters subject to section 10 of the Rivers and Harbors Act of 1899. These waters are defined at 33 CFR part 329.

Non-tidal wetland: A non-tidal wetland is a wetland that is not subject to the ebb and flow of tidal waters. Non-tidal wetlands contiguous to tidal waters are located landward of the high tide line (i.e., spring high tide line).

Open water: For purposes of the NWP, an open water is any area that in a year with normal patterns of precipitation has water flowing or standing above ground to the extent that an ordinary high water mark can be determined. Aquatic vegetation within the area of flowing or standing water is either non-emergent, sparse, or absent. Vegetated shallows are considered to be open waters. Examples of “open waters” include rivers, streams, lakes, and ponds.

Ordinary High Water Mark: An ordinary high water mark is a line on the shore established by the fluctuations of water and indicated by physical characteristics, or by other appropriate means that consider the characteristics of the surrounding areas.

Perennial stream: A perennial stream has flowing water year-round during a typical year. The water table is located above the stream bed for most of the year. Groundwater is the primary source of water for stream flow. Runoff from rainfall is a supplemental source of water for stream flow.

Practicable: Available and capable of being done after taking into consideration cost, existing technology, and logistics in light of overall project purposes.

Pre-construction notification: A request submitted by the project proponent to the Corps for confirmation that a particular activity is authorized by nationwide permit. The request may be a permit application, letter, or similar document that includes information about the proposed work and its anticipated environmental effects. Preconstruction notification may be required by the terms and conditions of a nationwide permit, or by regional conditions. A pre-construction notification may be voluntarily submitted in cases where preconstruction notification is not required and the project proponent wants confirmation that the activity is authorized by nationwide permit.

Preservation: The removal of a threat to, or preventing the decline of, aquatic resources by an action in or near those aquatic resources. This term includes activities commonly associated with the protection and maintenance of aquatic resources through the implementation of appropriate legal and physical mechanisms. Preservation does not result in a gain of aquatic resource area or functions.

Protected tribal resources: Those natural resources and properties of traditional or customary religious or cultural importance, either on or off Indian lands, retained by, or reserved by or for, Indian tribes through treaties, statutes, judicial decisions, or executive orders, including tribal trust resources.

Re-establishment: The manipulation of the physical, chemical, or biological characteristics of a site with the goal of returning natural/historic functions to a former aquatic resource. Reestablishment results in rebuilding a former aquatic resource and results in a gain in aquatic resource area and functions.

Rehabilitation: The manipulation of the physical, chemical, or biological characteristics of a site with the goal of repairing natural/historic functions to a degraded aquatic resource. Rehabilitation results in a gain in aquatic resource function, but does not result in a gain in aquatic resource area.

Restoration: The manipulation of the physical, chemical, or biological characteristics of a site with the goal of returning natural/historic functions to a former or degraded aquatic resource. For the purpose of tracking net gains in aquatic resource area, restoration is divided into two categories: Reestablishment and rehabilitation.

Riffle and pool complex: Riffle and pool complexes are special aquatic sites under the 404(b)(1) Guidelines. Riffle and pool complexes sometimes characterize steep gradient sections of streams. Such stream sections are

recognizable by their hydraulic characteristics. The rapid movement of water over a coarse substrate in riffles results in a rough flow, a turbulent surface, and high dissolved oxygen levels in the water. Pools are deeper areas associated with riffles. A slower stream velocity, a streaming flow, a smooth surface, and a finer substrate characterize pools.

Riparian areas: Riparian areas are lands next to streams, lakes, and estuarine-marine shorelines. Riparian areas are transitional between terrestrial and aquatic ecosystems, through which surface and subsurface hydrology connects riverine, lacustrine, estuarine, and marine waters with their adjacent wetlands, non-wetland waters, or uplands. Riparian areas provide a variety of ecological functions and services and help improve or maintain local water quality. (See general condition 23.)

Shellfish seeding: The placement of shellfish seed and/or suitable substrate to increase shellfish production. Shellfish seed consists of immature individual shellfish or individual shellfish attached to shells or shell fragments (i.e., spat on shell). Suitable substrate may consist of shellfish shells, shell fragments, or other appropriate materials placed into waters for shellfish habitat.

Single and complete linear project: A linear project is a project constructed for the purpose of getting people, goods, or services from a point of origin to a terminal point, which often involves multiple crossings of one or more waterbodies at separate and distant locations. The term “single and complete project” is defined as that portion of the total linear project proposed or accomplished by one owner/developer or partnership or other association of owners/developers that includes all crossings of a single water of the United States (i.e., a single waterbody) at a specific location. For linear projects crossing a single or multiple waterbodies several times at separate and distant locations, each crossing is considered a single and complete project for purposes of NWP authorization. However, individual channels in a braided stream or river, or individual arms of a large, irregularly shaped wetland or lake, etc., are not separate waterbodies, and crossings of such features cannot be considered separately.

Single and complete non-linear project: For non-linear projects, the term “single and complete project” is defined at 33 CFR 330.2(i) as the total project proposed or accomplished by one owner/developer or partnership or other association of owners/developers. A single and complete non-linear project must have independent utility (see definition of “independent utility”). Single and complete non-linear projects may not be “piecemealed” to avoid the limits in an NWP authorization. Stormwater management: Stormwater management is the mechanism for controlling stormwater runoff for the purposes of reducing downstream erosion, water quality degradation, and flooding and mitigating the adverse effects of changes in land use on the aquatic environment.

Stormwater management facilities: Stormwater management facilities are those facilities, including but not limited to, stormwater retention and detention ponds and best management practices, which retain water for a period of time to control runoff and/or improve the quality (i.e., by reducing the concentration of nutrients, sediments, hazardous substances and other pollutants) of stormwater runoff.

Stream bed: The substrate of the stream channel between the ordinary high water marks. The substrate may be bedrock or inorganic particles that range in size from clay to boulders. Wetlands contiguous to the stream bed, but outside of the ordinary high water marks, are not considered part of the stream bed.

Stream channelization: The manipulation of a stream’s course, condition, capacity, or location that causes more than minimal interruption of normal stream processes. A channelized stream remains a water of the United States.

Structure: An object that is arranged in a definite pattern of organization. Examples of structures include, without limitation, any pier, boat dock, boat ramp, wharf, dolphin, weir, boom, breakwater, bulkhead, revetment, riprap, jetty, artificial island, artificial reef, permanent mooring structure, power transmission line, permanently moored floating vessel, piling, aid to navigation, or any other manmade obstacle or obstruction.

Tidal wetland: A tidal wetland is a jurisdictional wetland that is inundated by tidal waters. Tidal waters rise and fall in a predictable and measurable rhythm or cycle due to the gravitational pulls of the moon and sun. Tidal waters end where the rise and fall of the water surface can no longer be practically measured in a predictable rhythm due to masking by other waters, wind, or other effects. Tidal wetlands are located channelward of the high tide line.

Tribal lands: Any lands title to which is either: (1) Held in trust by the United States for the benefit of any Indian tribe or individual; or (2) held by any Indian tribe or individual subject to restrictions by the United States against alienation.

Tribal rights: Those rights legally accruing to a tribe or tribes by virtue of inherent sovereign authority, unextinguished aboriginal title, treaty, statute, judicial decisions, executive order or agreement, and that give rise to legally enforceable remedies.

Vegetated shallows: Vegetated shallows are special aquatic sites under the 404(b)(1) Guidelines. They are areas that are permanently inundated and under normal circumstances have rooted aquatic vegetation, such as seagrasses in marine and estuarine systems and a variety of vascular rooted plants in freshwater systems.

Waterbody: For purposes of the NWPs, a waterbody is a jurisdictional water of the United States. If a wetland is adjacent to a waterbody determined to be a water of the United States, that waterbody and any adjacent wetlands are considered together as a single aquatic unit (see 33 CFR 328.4(c)(2)). Examples of “waterbodies” include streams, rivers, lakes, ponds, and wetlands.

ADDITIONAL INFORMATION

Information about the U.S. Army Corps of Engineers regulatory program, including nationwide permits, may also be accessed at <http://www.swt.usace.army.mil/Missions/Regulatory.aspx> or <http://www.usace.army.mil/Missions/CivilWorks/RegulatoryProgramandPermits.aspx>



Minnesota Pollution Control Agency

520 Lafayette Road North | St. Paul, Minnesota 55155-4194 | 651-296-6300

800-657-3864 | Use your preferred relay service | info.pca@state.mn.us | Equal Opportunity Employer

March 29, 2017

Mr. Chad Konickson
U.S. Army Corps of Engineers
Regulatory Branch Chief, St. Paul District
180 Fifth Street East, Suite 700
St. Paul MN 55101-1678

RE: Nationwide Permits – Clean Water Act Section 401 Water Quality Certification

Dear Mr. Konickson:

This letter is submitted by the Minnesota Pollution Control Agency (MPCA) under authority of Section 401 of the Clean Water Act (CWA) (33 U.S.C. § 1251 et seq.), Minn. Stat. chs. 115 and 116 and Minn. R. 7001.1400-7001.1470, 7050, 7052, and 7053. The MPCA examined the information furnished by the U.S. Army Corps of Engineers (USACE), including the final Nationwide Permits (NWP) issued by USACE Headquarters on January 6, 2017, and regional conditions proposed by USACE St. Paul District October 14, 2016, and is requiring conditions through the 401 Water Quality Certification.

The MPCA certifies the referenced general NWP because there is reasonable expectation that the activities identified within them will be conducted in a manner that will not violate applicable water quality standards provided the work is done in accordance with the following conditions, which shall become conditions of the NWP:

Conditions for All NWP Activities

1. The permittee must ensure that all waters of the United States in or bordering the construction areas that are not authorized to be impacted by the project are clearly identified prior to construction. This may be done through demarcation of the construction area on plan sheets or through marking boundaries in the field, for example construction staking, flagging, or the use of silt fences along boundaries. The permittee must not impact these areas while conducting activities under this permit.
2. Compensatory mitigation as required by NWP, General Condition 23, will satisfy the MPCA rules governing wetlands, Minn. R. 7050.0186.
3. The permittee must install in-water best management practices (BMPs) to minimize total suspended solids (TSS) and sedimentation for any work conducted below the ordinary high water level (OHWL) as defined in Minn. Stat. § 103G.005, subd. 14, of any water of the United States.

The permittee must document the in-water BMPs to be used during the authorized work prior to disturbing any land at the site; this documentation may be stand-alone or part of an Erosion Control Plan, Construction Plan, or other relevant construction document. This documentation is not required to be submitted to the MPCA, but must be kept on-site during active construction by the permittee or the permittee's contractor until the project is complete. Proper installation of BMPs is required before conducting the authorized in-water activities and properly maintained

throughout the duration of the project's in-water work. While conducting the authorized work, the permittee must visually monitor the BMPs to ensure that the BMPs are working as intended to reduce TSS or sedimentation. If the project activities cause an observable increase in TSS or sedimentation as described in Minn. R. 7050.0210. subp. 2 outside or downstream of the authorized defined working area, the project activities must immediately cease and any malfunctioning BMPs must be repaired, or alternative BMPs must be implemented. This Certification does not authorize the violation of applicable water quality standards outside or downstream of the defined work area. Minnesota water quality standards are located in Minn. R. 7050.

Information on the types of BMPs that may be suitable for in-water work is located in the Minnesota Department of Natural Resources Manual titled *Best Practices for Meeting DNR General Public Waters Work Permit GP 2004-0001*, located at: http://www.dnr.state.mn.us/waters/watermgmt_section/pwpermits/gp_2004_0001_manual.html.

The MPCA is responsible for interpretation of the requirements of this condition, determining compliance with the requirements of this condition, and enforcement of this condition. The point of contact at the MPCA for questions regarding this condition is: 401Certification.pca@state.mn.us.

4. The permittee must ensure that any dewatering activities do not create nuisance conditions as defined in Minn. R. 7050.0210. subp.2. BMPs must be used that minimize TSS and sedimentation by removing solids in the water before discharging the water. The permittee must document the in-water BMPs prior to beginning any dewatering; this documentation may be stand-alone or part of an Erosion Control Plan, Construction Plan, or other relevant construction document. The permittee must ensure that properly installed BMPs are in place before conducting the authorized activities and maintained throughout the duration of the dewatering work.

The MPCA is responsible for interpretation of the requirements of this condition, determining compliance with the requirements of this condition, and enforcement of this condition. The point of contact at the MPCA for questions regarding this condition is: 401Certification.pca@state.mn.us.

5. The permittee must ensure any earthen material used to construct or improve temporary or permanent dikes or dams, including cofferdams, or any roads, is contained in a manner that will prevent any of the earthen material from eroding. The permittee must completely remove temporary structures and restore original bathymetry, or contours at project completion.
6. It is the permittee's responsibility to ensure that the authorized activities do not exacerbate any existing impairments of a CWA 303-(d) listed impaired waters. The following MPCA webpages contain more information and search tools available to determine which waters in Minnesota are impaired: <http://www.pca.state.mn.us/lupg1125> and <http://www.pca.state.mn.us/mvri1126>. The applicable water quality standards are located in Minn. R. ch. 7050.

The MPCA is responsible for interpretation of the requirements of this condition, determining compliance with the requirements of this condition, and enforcement of this condition. The point of contact at the MPCA for questions regarding this condition is: 401Certification.pca@state.mn.us.

7. Any fill used in any water of the United States must be clean fill that is free of any solid waste, toxic or hazardous contaminants, and invasive species as defined in Minn. Stat. ch. 84D and Minn. R. ch. 6216,

including those discussed in "A guide to Nonnative Invasive Plants Inventory in the North by Forest Inventory and Analysis," 2009, C. Olson and A. Cholewa.

http://www.nrs.fs.fed.us/pubs/gtr/gtr_nrs52.pdf.

8. The permittee must provide: a) a copy of this Certification; b) documentation of any required BMPs under conditions 3 and 4; and c) any written demarcation of waters of the United States under condition 1; to any prime contractor responsible for completing the project's authorized activities. The permittee must also ensure that there is a mechanism in place requiring each prime contractor to provide the same information to all subcontractors, at any level, responsible for fabricating or providing any material for the project or performing work at the project site. In addition, copies of these documents and any other relevant regulatory authorizations related to impacts to Waters of the United States, must be available at or near the project site for use by contractors or staff responsible for completing the project work and must be available within 72 hours when requested by the MPCA staff.
9. The permittee is responsible for compliance with all applicable conditions of this Certification.
10. This Certification includes and incorporates by reference the general conditions of Minn. R. 7001.0150, subp.3.

Conditions Specific to Individual NWP Activities

In addition to all other applicable Certification conditions, the following activities must also comply with the activity-specific conditions below:

1. **NWP 7, Outfall Structures and Associated Intake Structures:** The permittee must ensure that impacts associated with outfall and intake structures do not harm aquatic life outside of the permitted project area and do not result in an unauthorized loss of waters of the United States without proper mitigation in accordance with General Condition 23 of NWPs.
2. **NWP 16, Return Water from Upland Contained Disposal Areas:** The permittee must ensure that return water from dredging that is directly returned to the original source water meet the same water quality standards that apply to the original source water. If the return water is discharged into a receiving water that is not the original source water, then the permittee must ensure that the discharge water will meet the more stringent water quality standard of the receiving water and the original source water. Discharges of return water must not violate the state water quality standard identified in Minn. R. 7050.0210. subp.2.
3. **NWP 53, Removal of Low-Head Dams:** The permittee must evaluate and manage the accumulated sediment behind the structure to minimize downstream effects during and following the removal of the structure. Use low-flow and winter construction and other appropriate BMPs required in conditions 3 and 4 below.

NOTIFICATIONS: The following notifications are not conditions of the MPCA CWA 401 Certification of NWPs. They provide practices that can help reduce the potential environmental impacts or they provide notification to the public in Minnesota, that certain discharges in Waters of the State, as defined in Minn. Stat. § 115.01, subd. 22, or activities associated with discharges into Waters of the State, are also regulated under other rules administered by the MPCA:

1. Minn. R. chs. 7001 and 7090 requires any activity that will disturb one acre or more of land must first acquire a National Pollutant Discharge Elimination System Permit (NPDES)/State Disposal System (SDS)

General Stormwater Permit from the MPCA for discharging stormwater during construction activity. Both the owners and operators of construction activity disturbing one acre or more of land are responsible for obtaining and complying with the conditions of the NPDES/SDS General Stormwater Permit prior to commencing construction activities. Sites disturbing less than one acre within a larger common plan of development or sale that is more than one acre also need permit coverage. A detailed Stormwater Pollution Prevention Plan (SWPPP), containing both temporary and permanent erosion and sediment control plans, must be prepared prior to submitting an application for the NPDES/SDS General Stormwater Permit. In addition, any project that will result in over 50 acres of disturbed area and has a discharge point within one mile of a special or impaired water is required to submit their SWPPP to the MPCA for a review at least 30 days prior to the commencement of land disturbing activities. If the SWPPP is out of compliance with the terms and conditions of the NPDES/SDS General Stormwater Permit, further delay may occur. For more information, please visit the following webpage: <https://www.pca.state.mn.us/water/construction-stormwater>.

2. Minn. R. ch. 7001.0030 requires that, prior to testing the structural integrity of any newly installed pipeline or any existing pipeline maintained or repaired that is authorized by NWP, the permittee must obtain NPDES/SDS Permit coverage from the MPCA. The NPDES/SDS Permit regulates the discharge of water and trench waters associated with this activity.
3. Chloride from winter road salt affects water quality. The MPCA encourages public road authorities pursuing projects under the general permit to consider the use of BMPs to reduce the use of chloride. General information about chloride and water quality, including the Draft Twin Cities Metropolitan Area Chloride Management Plan, is located at: <http://www.pca.state.mn.us/r0pgb86>.
4. When riprap is used, the permittee should consider placing riprap in the following manner:
 - a. Use natural rock (average less than 6 inches or more than 30 inches in diameter) that is free of debris that may cause pollution or siltation.
 - b. A filter of crushed rock, gravel, or filter fabric material can be placed underneath the rock.
 - c. The riprap should be no more than 6 feet waterward of the OHWL as defined in Minn. Stat. § ch. 103G.005 subd.14.
 - d. The riprap should conform to the natural alignment of shore and should not obstruct navigation or the flow of water.
 - e. The minimum finished slope waterward of the OHWL should be no steeper than 3 to 1 (horizontal to vertical).

Disclaimer:

Section 401 Certification does not release the permittee from obtaining all necessary federal, state, and local permits. It does not limit any other permit where requirements may be more restrictive. It does not eliminate, waive, or vary the permittee's obligation to comply with all other laws and state water statutes and rules through the construction, installation, and operation of the project. This Certification does not release the permittee from any liability, penalty, or duty imposed by Minnesota or federal statutes, regulations, rules, or local ordinances, and it does not convey a property right or an exclusive privilege.

This Certification does not replace or satisfy any environmental review requirements, including those under the Minnesota Environmental Policy Act (MEPA) or the National Environmental Policy Act (NEPA). In accordance with MEPA, Minn. Stat. § 116D.04, subd. 2b, and related rules, projects that are required to complete an

Mr. Chad Konickson

Page 5

March 29, 2017

Environmental Assessment Worksheet (EAW) or an Environmental Impact Statement (EIS) may not be started until:

- A petition for an EAW is dismissed
- A negative declaration on the need for an EIS has been made
- An EIS has been determined to be adequate
- A variance has been granted by the state Environmental Quality Board

An Environmental Review, required by law for any project, must be complete in order for any state permit or Certification to be valid.

The MPCA reserves the right to modify this Certification or revoke this Certification as provided in Minn. R. 7001.0170.

Pursuant to Minn. R. 7001.1450, failure to comply with any of the conditions in this Certification may result in the MPCA invalidating or revoking this 401 Water Quality Certification on a project-by-project basis.

If you have any questions on this Certification, please contact Jim Brist at 651-757-2245 or 401Certification.pca@state.mn.us.

Sincerely,



Melissa Kuskie

Supervisor

Certification, Environmental Review & Rules Section

Resource Management & Assistance Division

MK/JB:ds

cc: Janice Cheng, EPA
Peter Swenson, EPA
Wendy Melgin, EPA
Kerryann Weaver, EPA
Pete Fasbender, USFWS
Andrew Horton, USFWS
Luke Skinner, DNR
Julie Ekman, DNR
Jill Bathke, USACE
Andy Beaudet, USACE
Kristen Hafer, USACE